

Σ sigma 24



AHB

Mixing Art with Science

sigma

allen and Heath Brenell designs, manufactures, sells and services professional audio equipment. AHB is a name well known in many countries. The reputation of the company stands on the results of one activity which has been the same since the origin of the business as Allen and Heath in the early 1970s.

The company's aims have been consistent: to offer to the audio business products which are fit for use as commercial, income-earning hardware; to exploit proven electronic design and manufacturing techniques so that the end product offers high value to the purchaser.

Recent AHB designs now available offer innovative computer aided facilities as a result of investment in computer hardware and software design skills in-house. In a field of business where reputations gained over years can be lost overnight, AHB's reputation is protected by attention to detail in engineering design and manufacture. You, the purchaser, are the most important factor in our decisions.

The Sigma Series is a fully modular range of professional audio mixing consoles based on two frame sizes and a range of mono, stereo, in-line and group modules capable of being configured in a wide variety of operating formats for recording and live sound.

Considerable time has been spent listening to and questioning engineers, producers and musicians, and one thing that everybody agrees upon is that the most important aspect of any console design is that it sounds good, and Sigma most definitely does. With the advent of digital multi-track and mastering machines, noise and distortion are of the utmost importance, with lower noise than 16 bit digital playback, a dynamic range in excess of 100dB and a generous 22dB of internal headroom, Sigma really performs, giving you confidence which breeds success enabling you to make better masters and better masters make you more money.

Sigma has not only been designed to meet the rigorous demands of today, but also your future needs with an expandable frame system, the ability to update module types, retro-fit our VCA fader package, or a full fader automation system, Sigma is ready, it has the scope to develop and keep up with the recording techniques of the future.

To reinforce our commitment we have already included time-code synchronising hardware in all standard Sigma consoles. Many studio owners are finding that life without MIDI and SMPTE is holding back their operations. AHB's SSR Automute system puts channel and monitor fader mutes under computer memory control and with direct interface to MIDI clock systems including implementation of MIDI song pointer. Used with a SMPTE/MIDI converter the autolocator now initiates automated responses from the multi-track machine, sequencers, 16 MIDI effects and Sigma audio mutes.

We have not forgotten that your growth and success is our future, we are proud of Sigma now its your turn to be proud of a console that performs.

This folder contains all information on the frames, formats, modules and control systems in the SIGMA SERIES.

Extender Frame

24L Main Frame



SIGMA FRAME SYSTEMS:

24L; capacity for 48 modules, available with 24 and 16 output meters.
24S; capacity for 36 modules, available with 16 and 8 output meters.
Extender; capacity for 12 modules, left or right hand installation.
Producer's desk/patchbay; capacity for 15U of 19" standard equipment.
All items include stand, hardwood trims, power supplies and connecting cables.

AGENT'S ROLE

AHB sales and service is directed from the UK head office. The sales agent is recognised by AHB as an authorised representative for sales and service of AHB products. AHB has agreements with all agents for warranty policy and after sales service for which all agents are responsible.

Producers Desk/Patchbay
SSR Automute Controller



SIGMA AUDIO AND CONTROL SYSTEMS:

Individual consoles exploit all or part of the following system capacity depending upon the module types installed.

Mixing and output for 24 mono groups.

Mixing and output for one stereo main group.

Mono output of the stereo group.

Mixing and output for 8 mono auxiliary groups.

Monitor output from PFL and AFL in stereo

Monitor output from auxiliaries in stereo with talkback.

Reverse talkback input.

Talkback remote control.

Computer memory and recall of audio mute changes with synchronisation to MIDI with song pointer implementation.

WARRANTY

This product is guaranteed for a period of one year against defective parts and workmanship. Full details are provided on the warranty registration form.

SYSTEM FEATURES

Construction:

- Rigid tubular reinforced frames.
- Self contained active modules with bussbar system which allows module repositioning and service access.
- Modular fader bay, accepts Penny & Giles 150 panel.
- Gold on Gold bussbar connectors.
- 19" hardware patchbay system.
- Removable chassis plates for multiway connector installation.

Electronic/Operational Features:

- Balanced inputs and outputs of transformerless design with excellent transient response and common mode rejection ratio.
 - +4dBv normal level on XLR and jack connectors plus low level 300mV on RCA phono connectors for simultaneous connection of high and low level equipment.
- Multiple inputs to modules for pushbutton selection of sources.
- EQ with four variable sections, high pass filter and by-pass switch.
- 8 auxiliary send mixes of equal quality to match record and monitor outputs.
- Dedicated auxiliary output meters.
- Versions up to 24 track and 112 remix inputs, 56 with EQ and Automute.
- 3 fader options, non-automated, VCA grouping or fader automation.
- Silent FET mute switching on all input and monitor faders.
- 2 stereo cue sends with talkback.
- Line up oscillator with four frequencies.
- Talkback to cue, slate and master outputs.
- Triple checking facility – PFL, AFL and solo mu
- SSR Automute system and interface to MIDI based instruments lets Sigma respond to sequenced and timecoded electronic music sources.
- Audio paths designed with optimum signal to noise ratio, wide bandwidth, maximum dynamic range and low distortion performance. Industry standard high performance amplifiers used throughout.



SIGMA SERIES DIMENSIONS

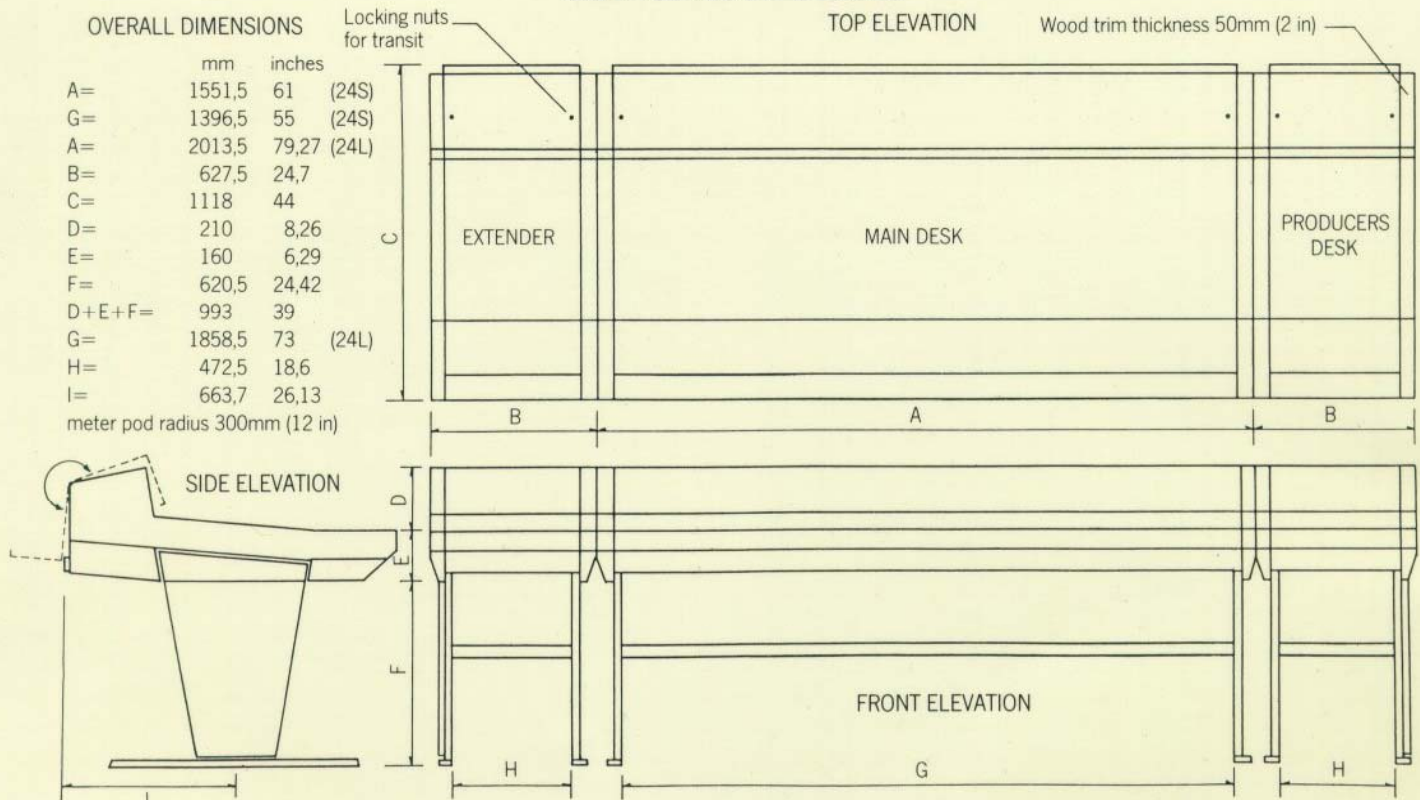

PERFORMANCE SPECIFICATION

The following performance figures apply to a typical Sigma configuration for 24 track operation.

GAIN: Measured between input and output with controls set for normal operation.

Microphone input, variable 70dB to 30dB. Additional 20dB pad.

Line input, +4dB, variable between -4dB and +20dB.

Tape input, unity gain, variable between -8dB and +16dB.

Tape input (low) has fixed 12dB gain stage in addition.

Return input variable up to +10dB.

Standard analogue faders for input, group output, main stereo outputs and monitor input all provide an additional 10dB gain when operated to maximum travel.

NORMAL OPERATING LEVEL: For OVU indication is +4dBv (1.23V RMS) sine wave at all line level inputs and outputs except the Tape Low circuits which are 300mV RMS for OVU.

MAXIMUM OPERATING LEVEL: Balanced outputs +22dBv (9.75V RMS) 600 ohms minimum.

Unbalanced outputs +22dBv (9.75V RMS) 5k ohms minimum.

INTERNAL OPERATING LEVEL: 0dBv (0.775V RMS) at insertion points and faders.

PHASE: All input and output connectors are in-phase except group insertion points which are inverted phase.

Phase convention: + pin 2 or tip contact, - pin 3 or ring contact.

common pin 1 or case contact

BANDWIDTH: Measured at maximum gain mic input to output ref 1kHz.

20Hz -2dB, 20kHz -0.5dB.

Measured at unity gain line or tape input to output ref 1kHz. 20Hz -1dB, 20kHz -0.5dB.

EQUALISATION: Module equaliser section details are given in the module descriptions.

NOISE: Figures are referred to OVU output level and measured with 20kHz bandwidths RMS meter unweighted.

Group output noise, fader at unity, no sources: -90dB

Group output noise, with one line input at unity gain, EQ flat: -86dB

Group output noise, fader at unity, 24 sources with faders closed: -80dB

Stereo output noise, fader at unity, no sources: -80dB

Stereo output noise, with one line input unity gain, EQ flat: -79dB

Stereo output noise, fader at unity, 24 sources with faders closed: -75dB

Microphone input noise -127dBm referred to a 200 ohm input.

Aux output noise, output at unity, sources closed: -80dB

DISTORTION: Measured as the sum of harmonic products and noise over a 20kHz bandwidth.

Input to output at unity gain below clipping

less than 0.08% at 100Hz, 0.02% at 1kHz, 0.05% at 10kHz

typically 0.005% at normal operating level.

Mic input to output at maximum gain below clipping

less than 0.08% at 100Hz, 0.05% at 1kHz, 0.05% at 10kHz

typically 0.01% at normal operating level

DISTORTION: Measured as intermodulation products 50Hz + 7kHz 4 : 1 method.

Input to output at unity gain below clipping

less than 0.025%

Note: distortion figures exclude distortion contribution from fader automation.

CROSSTALK: residual at measured output compared with input or hostile output.

Unweighted

L-R SEPARATION: 100Hz to 10kHz better than 60dB at main stereo output.

Output group separation: input via assign and pan to output; 100Hz to 10kHz better than 60dB.

Input mute shut off: better than 100Hz 70dB, 1kHz 75dB, 10kHz 60dB.

mbi AHB

ALLEN & HEATH BRENELL LTD

In line with our policy of continuous product improvement, we reserve the right to amend the design & specification of equipment without notice.

69 Ship Street,
Brighton BN1 1AE
Telephone (0273) 24928
Telex 878235 MBI AHB G

5 Connair Road, Orange,
Connecticut 06477 USA
Telephone (203) 795 3594
Telex 643307 AHB USA ONG

AHB 1-87 SF1

CONCEPT

In a dream world every console would have unlimited inputs, unlimited faders, unlimited aux sends, infinite equalisers, reset itself every session and come complete with a mind reading computer interface and be small enough to sit on your lap.

While we are working in that one we offer the Sigma Series as a practical solution to real sound control challenges available now at attractive prices. Look at the module summaries for details of the controls available. There are more module types available than it is necessary to install in any one Sigma console. Each console is the response to a particular sound control task. Your task may call for more inputs and fewer outputs, or sophisticated monitors or many simple monitors, in-line type controls or split "inputs left" "outputs right" controls or any combination.

The Sigma Series is AHB's response to the demand for increasingly sophisticated multitrack and live mixing consoles at increasingly attractive prices. Sigma consoles take over where

the low budget recording console runs out of muscle. Mixing and recording techniques are now well established, however the demands of special effects mixing, digital recording and electronic music have increased the demands on the console's capacity, versatility and performance.

Take for granted that the sonic performance of Sigma consoles is transparent for all practical purposes. What you will hear in the mix is your client's performance plus a little bit of noise, distortion and hum from your mics, instruments, multitrack and effects units. If you have been used to low budget consoles with clicking mutes, inconsistent pot laws and noisy inputs you will breathe a sigh of relief using Sigma. The designers of Sigma have listened to the complaints about low cost products. Sigma consoles are not big low cost products. Sigma consoles are for clients who want good sound consistently from reliable income — earning hardware.

MIXING/RECORDING TECHNIQUES WITH SIGMA MODULE SYSTEMS

Each module has an individual data sheet, here are summaries of the benefits of each standard console system.

M410 and M430 modules:

Split module system with inputs on the left, outputs on the right. The M430 is a high density module which compressed two outputs and monitor sections into a single module width, leaving more space for M410 inputs in a standard frame. Two large faders with each M430 provide the group outputs. Two monitor sections each have three sources; outputs, tape or (echo) return line inputs. One equaliser is shared between both monitors. Fader reverse allows mixing the monitor sources on large faders. Due to space limitations these faders are not automation capable.

This is the choice when space is at a premium and inputs more important than track monitors.

M410 inputs provide mic line and tape inputs so that the choice of source during recording and mixing does not involve replugging. With this system track bouncing is done via the input modules. SSR Automutes operate on the input fader and monitor level controls but not on the group outputs.

M410 and M420 modules:

Split module system with inputs left and outputs right. M420 modules are called line I/O types since one module provides output to tape and input from tape to the stereo mix AND group output. Of course, there is also the additional (echo) return line input source provided so that the module provides two functions: 1. mix and output, 2. monitor of output, tape input or return input.

A full set of input controls occupies most of the M420 panel. Group output controls are located above the large fader. The rest of the module is monitor input controls. These include assign to groups, EQ, aux send, mute and a small fader which may be reversed with the large fader below. Choose the way you want to work — output on large fader or monitor on large fader. Either way when it comes to bouncing tracks you simply select the new output. The valuable EQ and echo settings do not have to be copied across to an input module. This not only saves time it reduces the risk of an operator error.

M410 inputs provide mic line and tape inputs so that the choice of source during recording and mixing does not involve replugging. With this system track bouncing is done via the M420 modules. SSR automutes operate on the input faders and monitor faders but not on the group outputs.

Choose this combination when you want high performance from inputs and monitors and ergonomic efficiency. All faders in the M410/420 system can be non automated, VCA or automation types as an option.

M470 in-line module system:

All that is required for multitrack record overdub and remix. Each module provides three inputs and one output (to tape). The inputs are mic and line on the small fader (normally). The monitor input selects between output and tape input and uses the large fader (normally). For recording and bouncing operations the module works as a single entity to provide controls for record input to tape plus monitor input from tape to the monitor/remix output. Equalisation and aux send are shared between the input and monitor. Both inputs have the standard Sigma PFL/AFL, SOLO MUTE, MUTE AND AUTOMUTE. There is no fader for record output. Trim of record level is provided by a rotary control.

For mixing operations the primary function of the large fader is to mix the track with EQ and echo. The small fader can be used as a second input to the mix with echo send or as an additional echo send itself via assignment. Echo returns use spare modules and inputs. Analogue subgroups to the mix are available on modules 17-24 (16 track systems) and 25-32 (24 track systems) on small or large fader. Within a small frame M470 in line systems give the maximum facilities for highly efficient multitrack operations.

When the situation demands high priority for live inputs from many sources simultaneously, electronic music sessions for example, then the M470 system gives two line inputs to the mix simultaneously with EQ and echo send shared. Input reverse allows the choice of large or small fader preference to be given to the three source programmes at will.

All large faders in the M470 system can be non automated. VCA or automation types as an option. SSR Automutes operate on all small and large faders.

SSR AUTOMUTE SYSTEM

The SSR MIDI remote controller is a powerful micro computer enabling the automatic control of channel and monitor mutes as well as up to 16 effects devices under MIDI control. Pre programmed mute patterns and MIDI patch changes can be synchronised to a MIDI sequencer, driven from the SSR's internal sequencer or MIDI clock generated from SMPTE to MIDI converter, and the SSR recognises MIDI song pointer information.

The SSR can control a complete Sigma automute system of up to 64 inputs, up to 16 different MIDI controlled effects devices, enables MIDI keyboards and sequencers to have precise control over muting and effects, or the SSR can operate as a conventional music sequencer or computer recorder. In the sequencer mode it enables switching from one SSR MIDI programme plus one MUTE PATCH combination to another, under manual or automatic timing control.

There are 8 alternative clock options for operation in the sequencer mode allowing for different synchronisation methods.

CLOCK MODE 0

Manual footswitch stepping of MIDI and mute data, useful for work with pre-recorded material with no sync-track.

CLOCK MODE 1

As above but steps automatically to next song, enables more than 100 steps to be used under manual control.

CLOCK MODE 2

SSR runs the sequencer from its internal clock, from 29 to 320 BPM. The MIDI and MUTE data will be changed when the internal clock time and event times coincide.

CLOCK MODE 3

SSR driven from external clock 24 (sync 24) pulse code, with stop/start control, also providing SYNC 24 to MIDI converter.

CLOCK MODE 4

SSR controlled by MIDI timing data, START, STOP, CLOCK, CONTINUE START and SONG POSITION. Also providing MIDI to SYNC 24 converter.

CLOCK MODE 5

Data entry in real time with the internal clock. Each depression of a footswitch enters current song time into event timing data. Error correction via INSERT and DELETE facilities.

CLOCK MODE 6

Data entry in real time with timing data from SYNC 24 pulse code, with full error correction and editing facilities.

CLOCK MODE 7

This enables real time recording in synchronisation with MIDI clock, with full error correction and editing facilities.

The control unit is illustrated below approximately half real size and is a mobile panel connected to the console through a data cable.

All program data is stored in the KMM memory cartridge and libraries of data can be created to accompany synth discs and RAM packs for example.

SSR mute commands operate the console audio mutes in co-operation with manual local pushbutton mute commands. An un-muted channel (or monitor) responds to SSR mute and de-mute commands. A channel (or monitor) which is manually muted does not respond to SSR commands.

SSR is a unique innovative system which exploits MIDI for the benefit of the electronic music artist in particular. In applications which do not call for this benefit, the system may be operated without the SSR control unit, alternatively simply select a mute patch where all mutes are cleared.

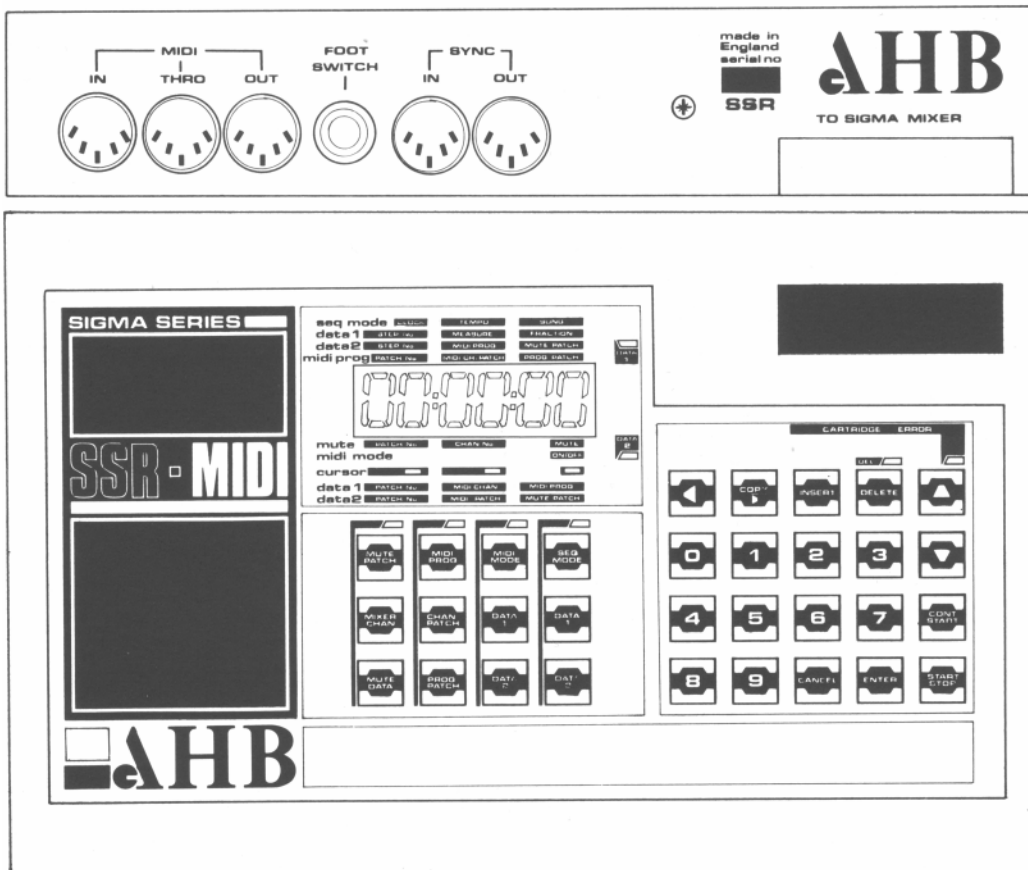

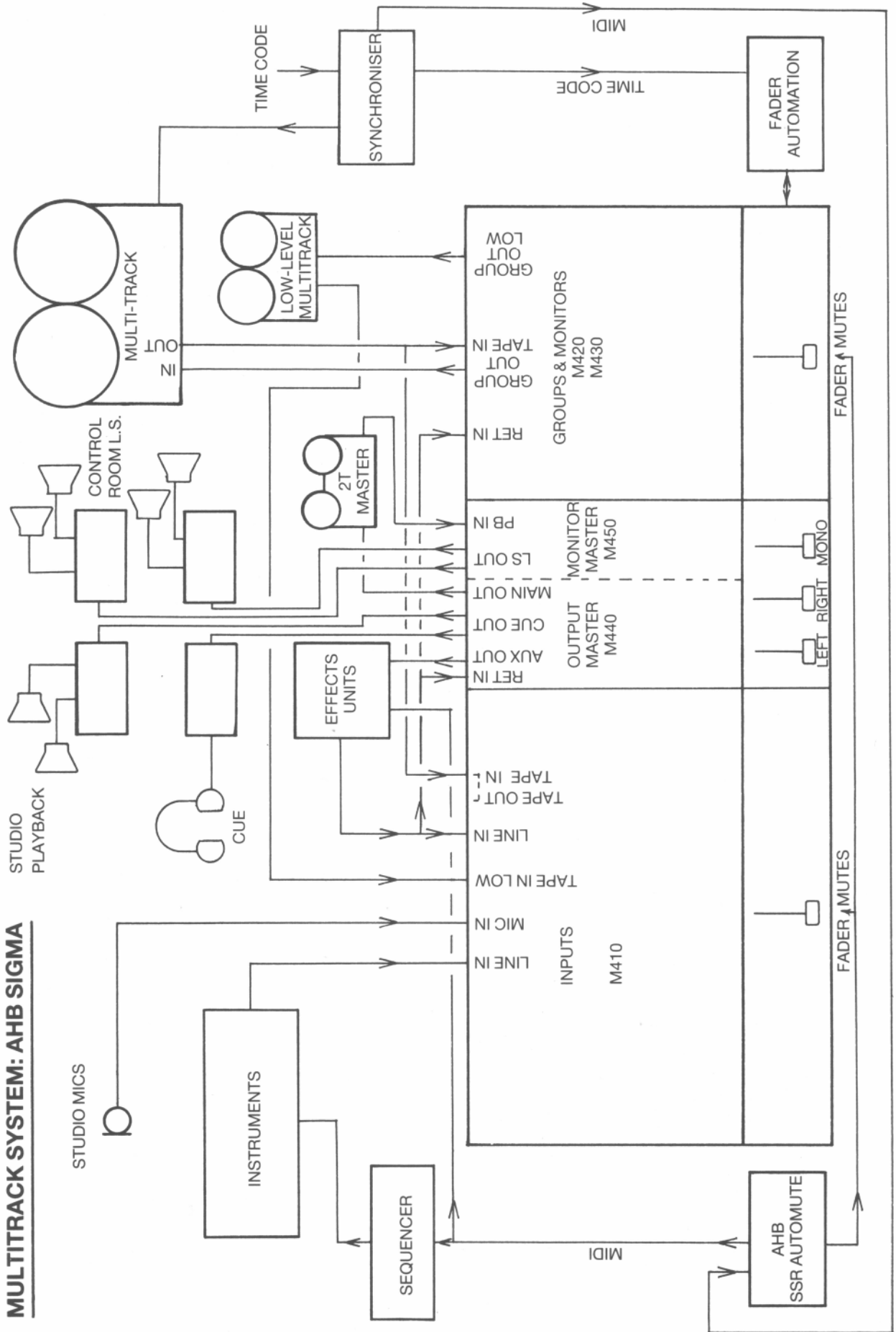

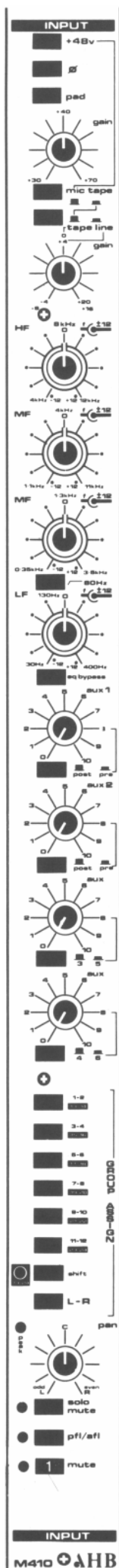

MODULE M410: MONO MIC/LINE INPUT.

- Phantom power on switch
- Mic input phase reverse switch
- 20dB mic input pad switch
- Mic input gain control

Input source selections: either mic or line or tape source is available.

Tape and line input GAIN control with gain indications.

EQUALISER section: pre fader, post insertion point. Dual concentric controls.

- HF shelving ± 12 dB. 4k Hz to 12 kHz range.
- MF peak/dip ± 12 dB. 1.1 to 11 kHz sweep range, Q =1
- MF peak/dip ± 12 dB. 0.35 to 3.5 kHz sweep range, Q =1

80Hz fixed frequency low-cut filter. 12dB/oct.

LF shelving ± 12 dB. 30Hz to 400Hz range.

EQ BYPASS operates on the four variable sections simultaneously.

AUXILIARY SENDS: four controls with six outputs.

- Aux 1 and 2 are switchable, pre or post fader. The pre fader selection is preset internally either pre equaliser or pre fader (ex works standard).
- Aux 3/5 and 4/6 are preset internally either pre equaliser, pre fader (post equaliser) or post fader (ex works standard).

GROUP ASSIGN selectors for group outputs 1 to 24 from input fader: six pushbuttons select twelve outputs in pairs.

- SHIFT selects either outputs 1 to 12 or 13 to 24.
- L-R assigns fader output to the main stereo output.
- PAN operates with the assign selectors.
- PEAK responds to pre fader, post eq signal level.

SOLO MUTE: with ENABLE (see M450) retains this input and operates the MUTE on all other inputs not selected SOLO.

PFL/AFL: operates control room loudspeaker and L/R meter changeover to receive either the PFL or AFL mix. PFL is pre fader listen. AFL is After Fader Listen. AFL responds to input pan and mute.

MUTE: press to mute the input post fader. Cuts post fader aux, assign and AFL. Also responds to SSR Automute and solo.

Fader: choice of 100mm analogue or Fader Automation.

MODULE M420: LINE INPUT/OUTPUT,

MONITOR section controls:

Input source selectors, choice of group output, tape input or return input.

Input GAIN for the selected source. Normal position central.

EQUALISER ASSIGN switch to either group output or monitor section.

EQUALISER section: pre fader, post insertion point. Dual concentric controls.

HF shelving ± 12 dB. 4 kHz to 12 kHz range.

MF peak/dip ± 12 dB. 1.1 to 11 kHz sweep range, Q = 1

MF peak/dip ± 12 dB. 0.35 to 3.5 kHz sweep range, Q = 1

80Hz fix frequency low cut filter. 12dB/oct.

LF shelving ± 12 dB. 30Hz to 400Hz range.

EQ BYPASS operates on the four variable sections simultaneously.

AUXILIARY SENDS: four controls with six outputs.

Aux 1 and 2 are switchable pre or post monitor fader.

The pre fader selection is preset internally either: pre equaliser or pre fader (ex works standard)

Aux 3/5 and 4/6 are preset internally to be either: pre equaliser, pre fader or post fader (ex works standard).

SMALL FADER: normally the monitor input fader to the group assign and post fader sends. See FADER REVERSE.

GROUP ASSIGN: selectors for group outputs 1 to 24 from the monitor input fader. Six pushbuttons select twelve outputs in pairs. SHIFT selects 1-2 or 13-24. L-R assigns to stereo output.

SOLO MUTE: with ENABLE (see M450) retains this input and operates the MUTE on all other inputs not selected SOLO.

PFL/AFL: operates control room loudspeaker and L/R meter changeover to receive either the PFL or AFL mix. PFL is Pre Fader Listen. AFL is After Fader Listen. AFL responds to input pan and mute.

MUTE: press to mute the input post fader. Cuts aux, assign and AFL. Also responds to SSR Automute and Solo.

FADER REVERSE: interchanges small and large faders. Pre and post sends not affected.

GROUP OUTPUT section controls: PAN ON connects the group fader output to the main stereo mix.

PFL/AFL operates in the same fashion as monitor PFL/AFL above.

MUTE: press to mute the GROUP OUTPUT post fader. Cuts output, pan and AFL. This mute is manual only and does not respond to Automute or solo system.

LARGE FADER: choice of 100mm analogue or Fader Automation.

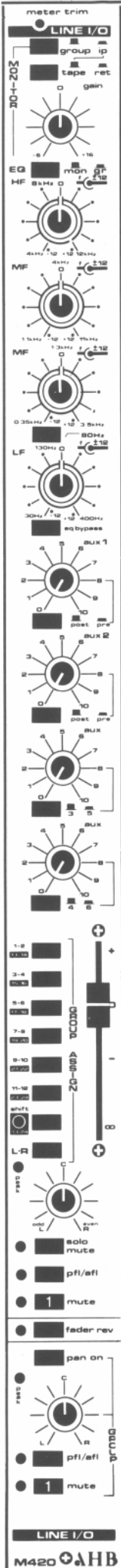

MODULE M430: DUAL OUTPUT/MONITOR

MONITOR section for ODD numbered output and inputs:

Input selector switches with three sources; group output, tape input, return input.

AUXILIARY SENDS: four dual concentric controls with six outputs.

Aux 1 and 2 are switchable pre or post the monitor level control.

The pre fader selection is preset internally either: pre equaliser or pre fader (ex works standard).

Aux 3/5 and 4/6 are preset internally to be either: pre equaliser, pre fader or post fader (ex works standard).

Monitor LEVEL and PAN are concentric controls. The inner 'level' adjusts output to the console stereo mix. The outer 'pan' adjusts image position.

SOLO MUTE with ENABLE (see M450) retains this input and operates the mute on all other inputs not selected SOLO.

PFL/AFL operates the control room loudspeaker and L/R meter changeover to receive either the PFL or AFL mix. PLF is pre monitor level. AFL is after monitor level and pan.

MUTE press to mute the input after the level control. Cuts aux, AFL and stereo outputs.

Responds to Automute and SOLO commands.

EQUALISER section: pre monitor level controls. Dual concentric controls.

HF shelving ± 12 dB. 4 kHz to 12 kHz range.

MF peak/dip ± 12 dB. 1.1 to 11 kHz sweep range, Q = 1

MF peak/dip ± 12 dB. 0.35 to 3.5 kHz sweep range, Q = 1

80Hz fix frequency low cut filter. 12dB/oct.

LF shelving ± 12 dB. 30Hz to 400Hz range.

EQ BYPASS operates on the four variable sections simultaneously.

EQ ASSIGN: places entire equaliser either in ODD or EVEN monitor.

MONITOR section for EVEN numbered output and inputs.

Facilities identical to ODD section above.

GROUP OUTPUT section controls for two outputs, one odd one even.

FADER REVERSE interchanges the large fader and the monitor level control. Pre and post fader sends are unaffected.

PFL/AFL operates the control room loudspeaker and L/R meter changeover to receive either the PFL or AFL mix. Group AFL is central mono.

MUTE press to mute the GROUP OUTPUT post fader. Cuts output and AFL. This mute is manual only and does not respond to Automute or SOLO system.

LARGE FADER: 100mm analogue fader. Part of 16 or 24 way panel.

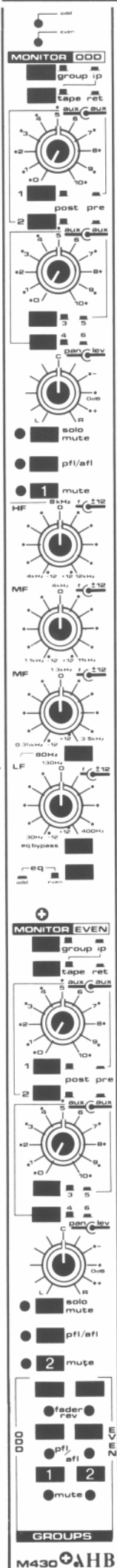

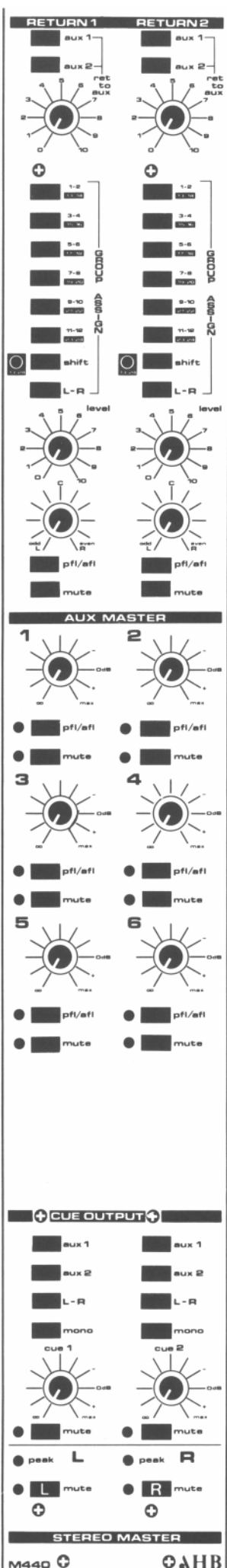

MODULE M440: STEREO MASTER, 76mm WIDTH

Two sets of identical controls provide console master output facilities and return input sections.

RETURN input section controls:

LEVEL control and selector switches for return to Aux 1 and 2.

GROUP ASSIGN selectors for return to group outputs 1-24 from the level control below. Six pushbuttons select twelve outputs in pairs. SHIFT selects either outputs 1 to 12 or 13 to 24.

L-R assigns return to the main stereo output.

LEVEL adjusts return to group assign and AFL.

Note that RETURN to AUX is preset pre LEVEL control.

PAN operates with the assign selectors.

PFL/AFL operates control room loudspeaker and L/R meter changeover to receive either the PFL or AFL mix. PFL is Pre Fader Listen. AFL is After Fader Listen. AFL responds to input Pan and Mute.

MUTE cuts off outputs post-level control. Not affected by console SOLO or Automute commands.

AUX MASTER output section controls. Six identical sections, eight on in-line console systems.

Output master level control numbered and calibrated.

PFL/AFL operates control room loudspeaker and L/R meter changeover to receive either the PFL or AFL mix. PFL is Pre Fader Listen. AFL is After Fader Listen. AFL is central mono and responds to MUTE.

MUTE: press to mute the output after the level control.

Cuts output and AFL. Not part of Automute or SOLO system.

CUE OUTPUT section controls. Two identical sections.

Three source selectors for the stereo cue output, Aux 1, Aux 2 and L-R can be operated singly or combined. Aux 1 feeds left cue output. Aux 2 feeds right cue output. Mono combines left and right cue outputs.

Cue 1 and 2 output master level controls are calibrated for normal position.

MUTE: press to mute the cue output.

CUE 1 and 2 receive talkback from the monitor master module.

Talkback operation dims the CUE source and superimposes TB speech.

STEREO OUTPUTS Left and Right. Two identical sections.

Peak responds to L and R pre fader mix level.

MUTE: press to mute the main stereo output L or R.

FADERS: 100mm analogue output faders.

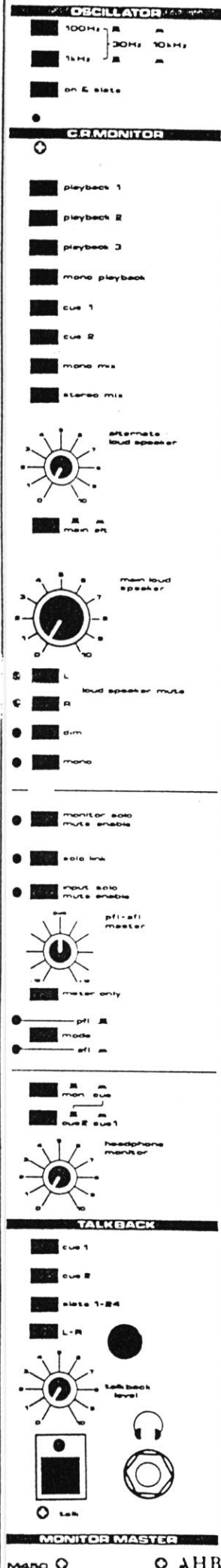

MODULE M450: MONITOR MASTER, 76mm width.

OSCILLATOR section. Choice of three operating frequencies. Generates a stable sine wave at fixed output level to panel socket and SLATE outputs. Trimmer access is provided for reference level adjustment. Refer to System Checkout section for details.

SOURCE selectors for control room monitor loudspeaker outputs. Playback sources 1 to 3 are stereo, PB 3 is 300mV operating level input. Eight sources available on the interlocked selector. Main L/R meters follow the C R monitor selected source. ALTERNATE loudspeaker output level control.

Selector switch for main or alternate speakers. The other is muted.

MAIN loudspeaker output level control. Loudspeaker MUTE pushbuttons Left and Right. Loudspeaker DIM pushbutton. Dim is automatically activated during talkback.

Mono pushbutton combines the L and R control room outputs to loudspeakers and meters.

SOLO MUTE master control section. ENABLE selectors must be pressed for SOLO MUTE to occur. SOLO LINK allows INPUT and MONITOR SOLO commands to act together.

PFL/AFL master control section. The trim level control adjusts the listening level to the control room loudspeakers. METER ONLY selector prevents changeover of speaker section from main programme to PFL/AFL. The mode of the section is either PFL or AFL determined by MODE pushbutton. Both sources are stereo capable.

HEADPHONE output section, level control for headphone volume with source selector pushbuttons. The MON source is the control room loudspeaker monitor programme.

TALKBACK section. Internal microphone picks up local speech. LEVEL control adjusts outgoing speech destinations selected on the four pushbuttons. Talkback is operated by pressing the TALK key. Control room loudspeaker outputs are automatically dimmed.

FADER: MONO OUTPUT 100mm analogue fader. Alongside the MONO fader is space for customised panel switches. The standard panel has five 16.5mm (21/32) holes.

AHB SIGMA M451 MODULE INFORMATION

The L - R meters connection socket on the top of the M451 module is now a "D" type connector as on the M440/M441 module, as opposed to two phono sockets originally fitted.

SIGMA I/O IN-LINE SYSTEMS

The Sigma I/O design offers space saving, value for money, in-line consoles. The three standard formats are:-

32/24 in small frame	(1.55m — 61in)
44/24 in large frame	(2m — 79in)
56/24 extended large frame	(2.65m — 104in)

Each frame can be part filled allowing for easy future expansion. I/O modules can be loaded into frames with the master modules in any sequence required. The standard master module set is supplied including the M441 8 auxiliary send version. Other Sigma module types can be included if required.

The M470 in-line module is a complete record/overdub/remix system for three sources and one record output.

A great deal of design effort has been applied to make the M470 ergonomically efficient, with the most used controls being grouped nearest the fader, ie. mute, solo, pan and equalisation. The signal path switching is designed for minimum effort transfer from record/overdub/bounce and remix modes. An example of this is that when all the pushbuttons are released the module is in the correct mode to record a mic source on to tape with simultaneous monitoring on the large fader, therefore you are already rehearsing your final mix, with only two button presses track bouncing can take place. Each module is controlled for status locally there are no master controls or overrides, module status reminder indicators are included for source, eq and assignment functions.

The Sigma in-line system has generous and versatile facilities necessary for modern recording techniques. Five band eq switchable between the large and small fader, eight mixes for cue and effects sends. There are separate faders for input and monitor, each with a dedicated pan and gain trim control, solo mute, PFL and AFL checking and access to the auxiliary sends. Large fader SOLO has the benefit of SOLO SAFE which prevents SOLO MUTE occurring, necessary when echo returns are wanted in a solo section. The MIC/LINE source section is a true dual input. Line input is dedicated for use by instruments and echo returns. The output from the multitrack occupies the module tape input connection leaving MIC or LINE sources available as required.

Both faders can access the output assignment section; in the 'normal' mode priority is given to the pre-recorded source via the large fader to the mix, with the small fader being the 'live' input fader to the bus output. In 'reverse' mode 'live' inputs are controlled on the large fader section and small fader is the monitor to the mix.

The M470 in-line module has unique features that are a bonus in high performance remix operations.

The small fader can be switched to receive the large fader output, so that when all the auxiliaries are used up the small fader is used as an echo send fader, with mute, and assigned to a bus output, which is then patched to the echo device. Each fader has a path to the mix via its own pan pot so when necessary each module is a twin input device.

During remix when the first 24 faders are used for tracks some group faders may be needed. On non-automated consoles the system allows two solutions. Bus outputs can be patched to any spare fader and reassigned or added to the mix. Also the small fader can be configured to receive the bus output mix, performing as a group or subgroup fader and reassigned or added to the mix. This variation re-allocates the 'follow large' pushbutton as a 'normal' 'bus' source selector. Of course, maximum creative freedom is achieved when fader automation is installed and takes over group functions.

The design of the M470 module affords excellent sonic quality with transformerless balanced audio interfaces, low noise and distortion design, a generous 22dB of internal signal path headroom, with 100dB dynamic range. Mute switching is carried out by highly reliable solid state switches. The I/O module mic preamp is an improved version of the standard preamp having lower distortion; the bus output has an increased overload margin; the standard equaliser has been improved with the addition of switched bandwidth (Q) for the two midrange sections, switched bell or shelf characteristics for the HF and LF sections and a variable cut off frequency for the high-pass filter. The musical responses have been chosen with the benefit of listening tests and the improvement is achieved without degradation of noise or distortion performance.

The advent of mute sequence memory, pioneered by AHB on the Sigma Automute system gives MIDI sync of input and monitor mutes. Sigma in-line consoles not only benefit from improved ergonomic design of the control surface and operating systems but also all mute operations on small and large faders are recognised by the mute processor and stored in memory, thereby eliminating separate key entry of mute data. The console mute status at any time can be stored as a 'snap-shot' with memory identity for recall. There are 32 patch memories available for storing mute patterns, plus the 'in-progress' scratch pad memory. Real time access is now also possible from a MIDI sequencer to module mutes. This is the basis of the Sigma MIDI automation system which stores, recalls and up-dates the mute data in sync.

The in-line format of Sigma offers a great deal at present. The combination of sonic excellence, versatile and efficient control systems, and a compact layout that reduces operator fatigue adds up to a high performance console. It can be as straight forward or sophisticated as you chose with or without fader automation, with or without patchbay, part filled or fully filled frames.

The Sigma console concept allows you to plan for future needs with the ability to extend frames on-site, fader automation achieved on-site and module addition achieved on-site.

Finally, with AHB's on-going design programme new module types will become available, all compatible with existing frames, making Sigma the console for today's as well as tomorrow's studio.

AHB

Sigma series

MODULE M470 I/O SYSTEM

M470 CONNECTIONS: PATCHBAY INTERFACE OPTIONAL

1, 2, 3, 4, 5, 6, 1/4" JACK SOCKETS. 0dBv is 0.775v RMS. Minimum loads: balanced outputs 600 ohms, unbalanced 2K ohms.

1. Bus out, unbalanced, -2dBv. 22 ohm source impedance, +21dBv max.
2. Bus in, unbalanced, -2dBv. 18K ohm impedance.
Bus in/out are patched to create subgroups on large faders 25 upwards as required.
3. Large fader insert, breakpoint post EQ prefader. Unbalanced 0dBv, tip send, ring return. 22 ohm/5K ohm +21dBv max.
4. Small fader insert, breakpoint post EQ prefader. Unbalanced 0dBv, tip send, ring return. 22 ohm/5K ohm +21dBv max.
5. Tape in, input to large fader section, balanced, nominal +4dBv, tip +, ring -, 47K ohm impedance.
6. Line in, input to small fader section, balanced, nominal 0dBv, tip +, ring-, 15K ohm impedance.
7. Bus out, output to multitrack record input, balanced nominal +4dBv, pin 2+, pin 3-. XLR 3M. 50 ohm impedance +26dBv max.
8. Mic in, input to small fader section, balanced pin 2+, pin 3-. XLR 3F. Switched +48v phantom power is included. 2K ohm impedance.
9. Tape in (low): -10dBV (300mV) input to large fader section. Passes through the high level Tape in jack switch contacts. 50K ohm impedance.
10. Internal meter connection. Nominal +4dBv from 3.6K ohm.
11. Internal meter trim adjustment.

MODULE M470 I/O SYSTEM

12. Mic/line source select.
13. 48v phantom power on switch.
14. 15dB mic input pad switch.
15. Source reverse connects mic/line to large fader, bus/tape to small. Normally mic/line is small fader, bus/tape is large fader.
16. Separate mic and line gain controls. Mic range +70 to +30dB; line range +20 to -6dB.
17. Group assign: select 24 outputs in pairs. Connected to pan pot output of small or large fader, see 19.
18. Shift selects outputs 1 to 12 or 13 to 24.
19. Assign is normally connected to the small fader output. Select lge to switch the assign section onto the large fader. Status LED (55) turns on.
20. Bus trim, trim pot adjusts bus output level to tape +5dB, -10dB.
21. Bus trim enable switch.
22. Aux 1 and 2 send level controls.
23. Aux 1 and 2 switchable between small and large fader, normally in large fader signal path.
24. Select aux 1 and 2 pre or postfader.
25. Aux 3 and 4 send level controls.
26. Select aux 3 and 4 pre or postfader.
27. Select aux 3 and 4 to follow small or large fader.
28. Aux 5 and 6 send level controls.
29. Select aux 5 and 6 pre or postfader.
30. Select aux 5 and 6 to follow small or large fader.
31. Level and pan for auxes 1/2 or 7/8.
32. Select auxes 1/2 or 7/8.
33. Select aux 1/2 or 7/8 pre or postfader.
34. HF equaliser: shelving or bell characteristics between 2kHz and 16kHz with 12dB infinitely variable cut and boost on the inner control, frequency selection on the outer control.
35. Select HF shelf or bell characteristics. Normally shelving curve, when pressed gives a peak/dip (bell) curve characteristics to HF equaliser. Bell Q = 0.7.
36. Places EQ section in the large fader signal path. Controls 39 and 40 also are switched with the equaliser to the large fader.
37. MF equaliser peak/dip (bell) curve equaliser operating between 1kHz to 10kHz with 12dB infinitely variable cut and boost on the inner control and frequency selection on the outer control.
38. MF Q is normally 0.6 and can be sharpened to 2.5 with the pushbutton.
39. EQ phase reversal select. Phase reverse switch, inverts signal phase of the programme being equalised. Peak indicator responds to EQ output level and lights when 3dB headroom remains.
41. MF equaliser, peak/dip (bell) curve equaliser operating between 100Hz to 2kHz with 12dB infinitely variable cut and boost on the inner control and frequency selection on the outer control.
42. MF Q is normally 0.6 and can be sharpened to 2.5 with the pushbutton.
43. Press to select rumble filter, 12dB/octave slope. Cut off frequency is adjustable with control 45.
44. LE equaliser; dual concentric inner control gives 12dB continuously variable cut or boost with shelving or bell characteristic at 90Hz frequency.
45. Dual concentric outer section adjusts rumble filter cut off frequency between 20Hz and 400Hz.
46. Select bell or shelf characteristic for the LF equaliser. Bell Q = 1.6.
47. EQ switch, press for equalisation. Phase reverse and rumble filter are independent from the EQ in/out selector.
48. Pan pot for small fader, affects output to the stereo mix and the assign section.
49. Follow large connects small fader to the output of the large fader. The small fader can then be assigned to bus outputs and used as an additional echo send with level and mute. An internal link option changes this switch function so that small fader can select the bus output to tape as its source. This provides a subgroup which can be re-assigned to another output or added to the stereo mix.
50. Mix connects the small fader output to the stereo mix.
51. PFL-AFL for small fader signal. Interrupts loudspeakers and meters only. After fade listen is post pan-pot and mute.
52. Solomute for small fader, mutes other small faders not soloed.
53. Mute small fader, cuts aux sends and pan output. This mute responds also to solo commands and the mute processor synchronised memory system.
54. Small fader, normally the mic/line fader but see 15 source reverse. 60mm ultra smooth type fader, optionally P+G 3000 series.
55. Status reminder LEDs, grouped near the fader for high visibility.
56. Select large fader source either tape input or bus output.
57. Large fader source trim pot +16dB, -6dB range.
58. Mix mute cuts large fader from the stereo mix only.
59. PFL-AFL for large fader signal, operates as PFL AFL for small fader. Any number of sources can be selected simultaneously.
60. Solo safe prevents the large fader from being muted by other solos, useful for preserving echo returns.
61. Large fader pan pot, affects output to the stereo mix and the assign section.
62. Large fader mute, this mute is a superior fast acting pushbutton. It responds also to solo commands and the mute processor sync memory system.
63. Solo mute for large fader, mutes other large faders not soloed. Small and large fader solo systems have master enable controls in the M450 module.
64. Fader (not shown) 100mm large fader, normally the bus/tape fader but see 15 source reverse. Operates with the control group immediately above. Choice of ultra smooth regular carbon type, P+G 3000 series and fader automation.

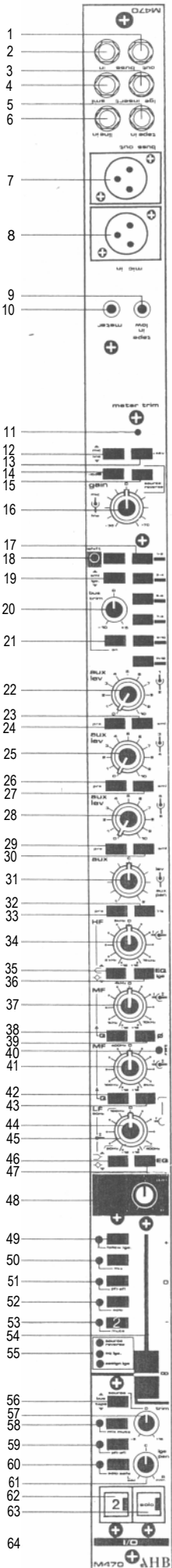

FADER MUTE SYSTEMS

Introduction

Sigma console include memory storage and recall of fader mute events with the facility to "replay" a sequence of mute events in synchronisation with an external source of time code.

Two fader mute systems are in use, each has unique features and is described in the following sections of this chapter. The systems are not inter-compatible or convertible.

The major features of the two systems are summarised below:

Automute SSR

Compatible with M410, M420, M430 module types.

Maximum capacity 64 mute switches.

Free standing control unit.

Mute changes entered on control unit by reception of module switch operations.

Mutes stored in patches, 100 per RAM pack.

Module mute switches mechanically latch.

Memory storage in RAM pack with battery back up. RAM packs exchangeable.

Interface with MIDI and SYNC 24.

MIDI "replay" controls sequences of mute patch recall and output to modules.

Mute switches function with or without the SSR Automute system.

Refer to AHB SSR operation. Technical data in section 11.

Mute Processor

Compatible with M470 module type, and future designs.

Maximum capacity 128 mute switches, two per M470 module.

Fader bay control panel M494.

Mute operations on individual modules are processed by MP and returned to the module this eliminates repetition.

Mutes stored in patches, 32 patches available.

Module mute switches are momentary non-latching types.

Memory storage in internal RAM with battery back up.

Interface with MIDI.

MIDI "replay" controls sequences of mute patch recall and output to modules. MIDI "replay" also controls individual mutes.

Mute switches do not function without the Mute Processor system.

Refer to Mute Processor operation. Technical data in section 12.

SSR OPERATING INSTRUCTIONS

Introduction

The SSR unit is the remote control unit for the Sigma Series Automute system. The automute system allows programming and synchronising of channel mute and monitor mute functions. As well as control of the Sigma mutes the SSR provides control of MIDI effects devices. A flat ribbon cable connects the SSR to the Sigma mixer, the SSR can therefore be positioned on the mixer as required or operated as a handheld or lap unit.

The SSR Control Unit

The SSR unit can control a complete Sigma automute system provide automated muting for up to 64 inputs. It also transmits and receives MIDI and SYNC 24 data.

The unit features a 6 digit back-lit LED display and touch switches for programming. All the programmed data is stored in the KMM memory cartridge.

The KMM is a RAM cartridge with 10 years battery back-up. It must be inserted correctly into the top panel slot of the SSR, otherwise the 'CARTRIDGE ERROR' LED will light and the SSR keypad will be locked out. Once inserted, all information stored in the KMM is accessible and after a couple of seconds the SSR is fully operational. The cartridge error LED is also designed to light in more unlikely situations - damaged connector or malfunctioning circuitry.

Each cartridge can store 100 mute patches, 100 MIDI control parameters, MIDI look up table with 100 entries, and up to 10 individual 'songs' of 100 steps with a chaining facility to produce a continuous sequence of 1000 steps - each step containing a mute and MIDI control patch number.

Each mute patch holds a complete set of channel (1 to 64) mute designations. The programme mute patch can set muting of all channels and monitors connected to the automute system. The mute status is displayed on the channel strips beside the mute button.

Installation

The relationship between console module and automute channel is shown for several typical consoles below:

Model	Automute channel numbers	
	Input Sequence	Monitor Sequence
24L 20 X 24 (410/420)	1-20	21-44
24L 28 X 16 (410/420)	1-28	29-44
24L 32 X 24 (410/420)	1-32	33-56
24L 32 X 24 (410/430)	1-32	33-55 ODD 34-56 EVEN

SIGMA SERIES SSR AUTO MUTE SYSTEM

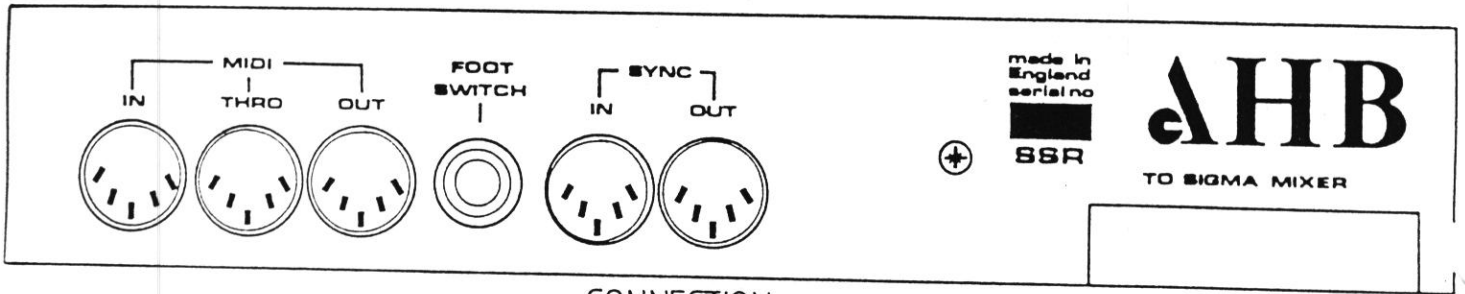

CONNECTION

MEMORY CARTRIDGE

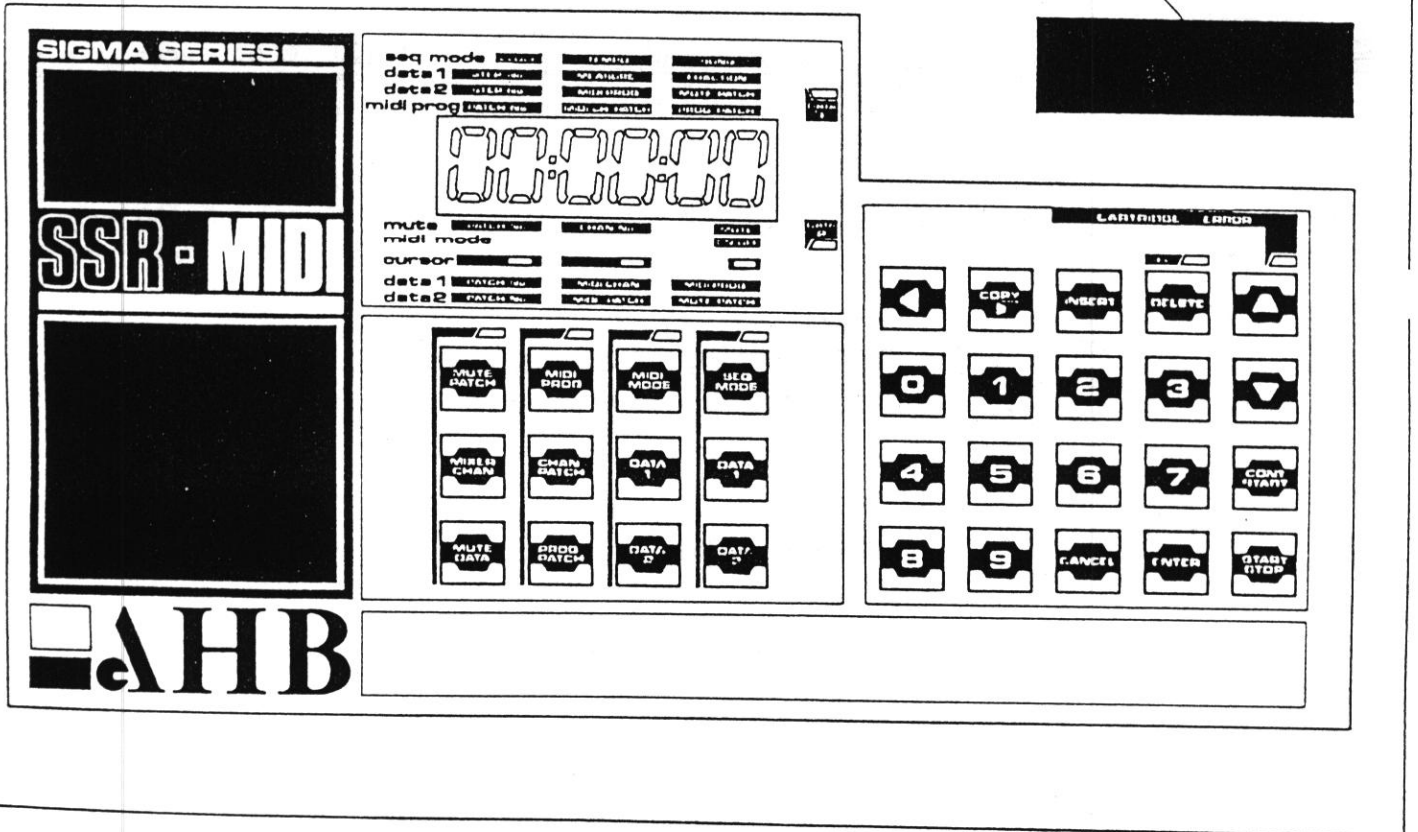

CONTROL PANEL

Using the SSR

The SSR has 4 operating modes. Two are used to write information into the RAM memory about the mixer settings and MIDI control settings, and two are used as 'performance' modes to access the information.

The 6 digit display is used to check the stored and entered information. There are LED 'cursor' indicators and these, combined with the text labels above and below the display, assist programming.

To get information into the SSR, simply press the appropriate squares on its top surface (these have switches underneath with a positive feel and audible 'click'). All number entries (one or two digits at a time) should be followed by ENTER to complete the entry, otherwise it will NOT be recognised. Although most numbers are shown as two digits, it is not necessary to key in the leading zero, for example, of number 05. Just enter 5. The CANCEL key can be used to delete incorrect entries.

When the power to the SSR is first switched on the SSR is set to the MUTE PATTERN mode and mute patch 00 is displayed and output to the mixer.

The 4 possible operating modes are:

MUTE PATCH MIDI PROGRAMME MIDI MODE SEQUENCE MODE

and they can be accessed by pressing the appropriate mode key. An LED will light above the mode key pressed, any of the functions in the column below that LED can then be accessed.

1) Mute Patch

This mode enables the setting of the mute status on the channels for storage within the selected patch.

DISPLAY

Mute:	PATCH No.	CHANNEL No.	MUTE
Entry:	00-99	1-64	0 = ON 1 = MUTE
Cursor:	LED	LED	LED

Each PATCH (0-99) can mute any combination of the available channels.

Set up your muting as follows:

- i) Having selected MUTE PATCH mode, the patch currently controlling the mixer will be displayed. If you wish to use another patch then enter the memory patch number using the number keys. Key in a patch number from 0-99. If you make a mistake use the cancel key to erase the number and then re-enter the correct number. Press ENTER to complete the entry.

The patches can be stepped through sequentially, up and down, using the '^' and 'v' keys to allow fast visual checking of patches by observing the mixers settings for each patch.

- ii) Press MIXER CHAN and the cursor LED will move to below the channel number data. Type in the required channel number from 1 to 64 and press ENTER. The current mute data related to that channel will then be displayed in the mute column. If you wish to step through the channels within the patch to see the individual mute data, the '^' and 'v' keys can be used.
- iii) Press the MUTE DATA key and the cursor LED will move to below the mute data. Enter number 0 to switch the displayed channel ON, or enter 1 to mute the channel currently displayed.

To speed up data entry the enter key can be used as a single key operation to change the current channels mute status. Use the '^' and 'v' keys to step from one channel to another for easier data entry.

- iv) To program muting for another PATCH, press the MUTE PATCH key and repeat steps (i) to (ii) and (iii).
- v) To copy one memory patch to another, first select mode then enter the MUTE PATCH mode then enter the MUTE PATCH to be copied. Press the '>' key followed by the new patch number for placing the copy. Remember to press ENTER after both number entries.
- vi) A mute patch can be reset to the all channels on state using the DELETE key. This function is only available in the MUTE PATCH mode with the cursor below the patch number. The DELETE key is a double action whereby the first press lights on LED to warn of impending deletion, second press would then delete the data stored in the displayed MUTE PATCH. To abort the deletion at this point simply press MUTE PATCH mode again.

Now you can begin to make use of the mute patches you have programmed into the SSR. Both MIDI and SEQUENCER modes give you some powerful operating combinations.

2) Midi Program

This mode enables the control of external midi devices, such as effect units. The MIDI PROGRAM CHANGE control word can be sent out on any of the 16 MIDI channels to select any one of 100 programs. The data is arranged in two sections in a 100 element table. Patch numbers 0 to 49 each contain a MIDI channel number and MIDI program number. Numbers 50 to 99 each contain two patch numbers to enable multiple MIDI control outputs.

DISPLAY

MIDI Prog:	PATCH No.	MIDI CH/PATCH	PROG/PATCH
Entry:	0-49	1-16	0-99
Entry:	50-99	0-99	0-99
Cursor:	LED	LED	LED

Set up your MIDI control parameters as follows:

- i) Having selected MIDI PROG mode, enter the patch number required using the number keys. Key in a patch number from 0 to 49 to program individual MIDI control outputs, or 50 to 99 to program multiple MIDI control outputs. If you make a mistake use the CANCEL key to erase. Press ENTER to complete the entry. The patches can be stepped through sequentially, up and down, using the '^' and 'v' keys to allow fast visual checking of the data.
- ii) Press the CHAN/PATCH key and the cursor will move to below the relevant data. For patches 0-49 this data is the MIDI channel number on which the program change message is to be sent, so enter a number between 1 and 16 as required.

For patches 50-99 this data is another patch number 0-99 so that when the current patch is selected this patch number is called up and the information stored there is executed.
- iii) Press the PROG/PATCH key and the cursor will move to below the PROG/PATCH data. For patches 0-49 this data is the MIDI program number to be transmitted, so enter a number between 0-99 as required. For patches 50-99 the data is as in (ii) above.

Examples

- a) To program a string of changes for a single MIDI effect unit:

PATCH No.	MIDI CH/PATCH	PROG/PATCH
00	01	05
01	01	07
02	01	70
03	01	50

Here stepping through these patches will cause the MIDI device to select programs 5,7,70,50 or other programs associated with these MIDI codes.

b) To program a multiple change of MIDI effect units on different channels:

PATCH No.	MIDI CH/PATCH	PROG/PATCH
00	01	05
01	02	07
50	00	01

Here calling up patch 50 will cause the SSR to send out MIDI program number 5 to the unit set to receive on channel 1 and program number 7 to the unit set to channel 2.

c) The principle shown in example (b) can be extended as follows:

PATCH No.	MIDI CH/PATCH	PROG/PATCH
00	01	05
01	02	07
02	03	70
03	04	50
04	05	10
50	00	01
51	02	03
52	04	51
53	50	52

Now calling up patch 53 will produce the following result:

MIDI DEVICE	ON CHANNEL	PROG SELECTED
1	1	5
2	2	7
3	3	70
4	4	50
5	5	10

3) Midi Mode

In this mode the SSR can provide comprehensive control of MIDI effects and the mixer under the control of MIDI keyboards, etc. A 100 element look up table is provided which can assign received MIDI program change commands on any channel to mute patch and MIDI prog. data in the SSR. This allows modern MIDI based studios to have precise control of the mix and effects when using sequencers and keyboards.

DISPLAY

MIDI Mode:			ON/OFF
Entry:			0-1
Data 1:	PATCH No.	MIDI CHAN	MIDI PROG
Entry:	0-99	1-16	0-99
Data 2:	PATCH No.	MIDI PROG	MUTE PATCH
Entry:	0-99	0-99	0-99
Cursor:	LED	LED	LED

The MIDI MODE is set up as follows:

- i) Press the MIDI MODE key, the display will show a single 0 indicating MIDI MODE 'off' and the cursor LED will light at the ON/OFF position. Press 1 followed by ENTER to switch this mode on. Whenever another mode is selected the MIDI MODE will be switched off.

The 'DATA 1' steps (ii) to (vi) that follow let you set up MIDI program number and channel number for each of the midi patches. The 'DATA 2' steps (vii) to (xi) let you set up a MIDI PROG and MUTE PATCH for each MIDI PATCH.

- ii) Select DATA 1 by pressing the DATA 1 key in the MIDI MODE column. The display will then show PATCH No., MIDI CHANNEL and MIDI PROGRAM with the cursor under the PATCH No. and the DATA 1 LED lit.
- iii) Enter a patch number from 0-99. Press ENTER to store the number. Use CANCEL as before if an error is made. The '^' and 'v' keys can be used to step through the patches.
- iv) Use the '>' and '<' keys to move the cursor across the display and position it below MIDI CHAN or MIDI PROG ready for new data entry.
- v) Change MIDI CHAN by entering a channel number from 1 to 16 with the cursor LED below MID CHAN lit.
- vi) Change MIDI PROG by entering a program number from 0 to 99 with the cursor LED below MIDI PROG lit.

Entries (v) and (vi) have then set the combination of a program number on a particular channel that will be transmitted by the MIDI device connected to the SSR MIDI IN.

Remember to check the relationship of the transmitted MIDI device program numbers and the MIDI program numbers being set in the patches. For example, a MIDI keyboard may have its programs in banks, from 1 to 8 then 11 to 18, 21 to 28 and so on. These usually correspond to MIDI program numbers in consecutive fashion so that programs 11,12,13,14, etc is in this instance become 9,10,11,12,etc. A few quick checks in the MIDI devices manual should sort out any problems.

- vii) Select DATA 2. The display will then show PATCH No., MIDI PROG and MUTE PATCH with the cursor under the PATCH number and the DATA 2 LED lit.
- viii) The patch number displayed is the same as that set while entering information in the DATA 1 position. Thus, if you are now assigning a MIDI PROG and/or a MUTE PATCH to the MIDI data set up in DATA 1 there is no need to enter a patch number. The '^' and 'v' keys can be used to step through the patches and a new patch number can be entered as normal if required.

- ix) Use the '>' and '<' keys to move the keys across the display and position it below MIDI PROG or MUTE PATCH ready for data entry.
- x) Change MIDI PROG by entering a number from 0 - 99 with the cursor LED below MID PROG lit. This enables a set of MIDI output parameters for program change to be assigned to the received MIDI data that was programmed in DATA 1.
- xi) Change MUTE PATCH by entering a number from 0-99 with the cursor LED below MUTE PATCH lit. This enables a mute patch, with mute data for the mixer, to be assigned to the received MIDI data that was programmed in DATA 1.

Remember MIDI mode only works if it is enabled as described in step (i). While operating the display can be set to display either MIDI MODE, DATA 1 or DATA 2 to enable easy checking of system operation.

Example

MIDI MODE			1
DATA 1	00	01	03
DATA 2	00	10	05

Here when the SSR receives the MIDI program change message 03 on MIDI channel 1, it will send out the MIDI data stored in MIDI PROG patch 10 and update the mixer with the mute data stored in MUTE PATCH 05. If the data received by the SSR does not match that stored in any of its 100 patches then the data is ignored and the MIDI PROG and MUTE PATCH'S will remain unchanged.

4) Sequencer Mode

This mode lets you program and operate the SSR like a conventional music sequencer or computer recorder. Instead of recording music data, it enables you to switch from one SSR MIDI PROG plus MUTE PATCH combination to another. It is similar to MIDI mode in this respect, except that it switches from one combination to the next either under manual or automatic timing control.

There are 8 alternative clock options for the sequencer for different synchronisation methods:

DISPLAY

SEQUENCE MODE:	CLOCK	TEMPO	SONG
Entry:	0-7	19-99	0-9
Cursor:	LED	LED	LED

- i) To select a clock mode, enter the number required, with the cursor LED below the clock column lit.

CLOCK MODE 0

In this mode the timing data of the sequence is ignored and the sequencers events are stepped through using a footswitch. This enables any song to be programmed with MIDI and MUTE data and then stepped through sequentially until the end of the song is reached. This mode is ideal for using the SSR facilities with pre recorded material with no sync track.

CLOCK MODE 1

This mode is as mode 0 except that when the end of a song is reached the sequencer goes on to the start of the next song until the end of the last one. This enables sequences longer than 100 steps to be used under manual control.

CLOCK MODE 2

The SSR will run the sequence from its internal clock. The tempo can be programmed from 29 to 320 beats per minute (BPM) using a scale of values given in the internal clock tempo chart at the end of this section. The MIDI and MUTE data will be changed when the internal clock time is the same as the event time.

While running in this mode the SSR also outputs SYNC 24 and MIDI timing code to allow synchronisation of other equipment.

In addition MIDI 'song position pointer' information is generated to enable MIDI sequencers and drum machines to follow the song measure number.

CLOCK MODE 3

In this mode the sequence timing is derived from the SYNC IN socket on the rear panel. The sync signal must provide a start/stop control and a clock with 24 pulses per quarter note.

The SSR will also output SYNC 24 and MIDI timing data in this mode, this also providing a sync 24 to MIDI converter.

CLOCK MODE 4

This mode enables the SSR to be controlled by MIDI timing signals START, STOP, CLOCK, CONTINUE START and SONG POSITION. SYNC 24 output is also available in this mode providing a MIDI to SYNC 24 converter.

MIDI THRU is provided to allow the received MIDI data to be passed on to other MIDI equipment.

The SSR will follow MIDI song position pointer information and will search for any bar in the 10 available songs. The sequence will find the event with the nearest bar to the one currently being pointed to.

CLOCK MODE 5

The timing data for the sequences can be entered in steps or programmed in real time. This mode enables the timing data to be programmed in real time with the internal tempo clock. Each depression of the footswitch, once the sequencer is running, will enter the current song time into the events timing data. Any errors can be corrected later using the INSERT and DELETE facilities.

CLOCK MODE 6

This mode is as mode 5 but the timing for the real time recording is taken from the SYNC 24 clock input.

CLOCK MODE 7

This mode enables real time recording in synchronisation with the MIDI clock.

Internal Mode Tempo Chart:

Display	BPM	Display	BPM
99	320	53	104
98	310	52	102
97	300	51	100
96	290	50	98
95	280	49	96
94	270	48	94
93	260	47	92
92	250	46	90
91	240	45	88
90	230	44	86
89	225	43	84
88	220	42	82
87	215	41	80
86	210	40	78
85	205	39	76
84	200	38	74
83	195	37	72
82	190	36	70
81	185	35	68
80	180	34	66
79	175	33	64
78	170	32	62
77	165	31	60
76	160	30	58
75	157	29	55
74	153	28	52
73	150	27	50
72	148	26	48
71	145	25	45
70	142	24	42
69	140	23	40
68	137	22	37
67	133	21	33
66	130	20	30
65	128	19	29
64	126		
63	124		
62	122		
61	120		
60	118		
59	116		
58	114		
57	112		
56	110		
55	108		
54	106		

- ii) To set a tempo for the internal clock modes (2 or 5) enter the number required from 19 to 99, with the cursor LED below the tempo column lit. Use the '>' and '<' keys to move the cursor. The relationship between the tempo numbers and BPM are given in the tempo table.

The '^' and 'v' keys can be used to increase and decrease the tempo as required with the sequencer stopped or running, thus allowing fine adjustment to be made during replay.

- iii) To select a song, enter a number from 0 to 9 with the cursor LED below the SONG column lit. Use the '<' and '>' keys to move the cursor. Each song has its own set of clock and tempo data associated with it and changing the song will cause that songs clock and tempo data to be displayed.

- iv) DATA 1

data 1:	STEP NO	MEASURE	FRACTION
entry:	0-99	1-99	1-96 + 97,98,99
cursor:	LED	LED	LED LED DATA 1

Pressing the DATA 1 key will bring the sequence timing data onto the display. The current sequence step no. will be shown along with the associated timing data. The '^' and 'v' keys can be used to step through the events. The cursor is positioned using the '<' and '>' keys.

The measure column contains the timing data which represents 96 clock pulses. In 4/4 timing the measure is equivalent to a bar. Enter a number between 1 and 99. If the sequence calls for more than 99 measures, then the numbers can be repeated so that the second occurrence of measure 1 would be effectively measure 100. The fraction is, as it implies, a subdivision of the measure. There are 96 fractions to a measure thus, allowing very high resolution timing to be set up. The fraction column can also contain numbers higher than 96, but these are code numbers.

<u>FRACTION</u>	<u>APPLICATION</u>
97	Repeat. Sends the sequence back to step 0 of the current song and repeats until the sequencer is stopped.
98	Next song. Used in clock modes 2-4 to allow a sequence to continue into the next song, and allows programming of a chained sequence of up to 10 songs (1000 steps) length. When the sequencer moves onto the next song the tempo register is reset to the value programmed in association with the new song. This allows tempo changes to be programmed when using the internal clock. The clock changes as it assumes the sequence will be under the control of one device for its duration.
99	Stop. End of song or sequence of songs.

Fraction codes 97-99 are asked on as soon as that sequence step is reached. Care is needed in their placement in the sequence to ensure the sequence is kept in time. For example, if a repeat is required at the end of a bar in 4/4 time that bar should have a fraction of 95 in the step before the repeat fraction 97 in that bar. This will ensure the repeat is performed on the 96th fraction of the measure during which the repeat is required. Similar care may be needed with other control codes.

v) DATA 2

data 2:	STEP No.	MIDI PROG	MUTE PATCH
entry:	0-99	0-99	0-99
cursor:	LED	LED	LED LED DATA 2

Pressing the DATA 2 key will bring the sequence MIDI and MUTE data onto the display. The current sequence step no. will be shown along with the associated MIDI and MUTE patches. The '^' and 'v' keys can be used to step through the events and the '<' and '>' keys are used to position the cursor.

The MIDI PROG column contains the MIDI PROG number that will be called up and transmitted when the sequencer reaches that step.

The MUTE PATCH column contains the MUTE PATCH number that will be called up and sent to the mixer when the sequencer reaches that step.

vi) SEQUENCE EDITING

Steps can be inserted into or deleted from the sequence while in DATA 1 or DATA 2 positions.

When the INSERT key is pressed, an extra event is inserted at the current step number. The data previously occupying that event move up one step as do all subsequent events. The inserted event is given default values of:

MEASURE	FRACTION	MIDI PROG	MUTE PATCH
01	01	00	00

The DELETE function is the reverse of the insert function above, and will cause the displayed event to be removed from the sequence and all subsequent events to be moved down 1 step. The delete key is a double action key to avoid accidental operation. The first press lights a warning LED and the second press deletes the event. To abort the delete simply press DATA 1, DATA 2 or SEQ MODE as required.

RUNNING THE SEQUENCER

The sequencer can be started and stopped by the START/STOP key in all clock modes and with the display showing either SEQ MODE, DATA 1 or DATA 2. While the sequencer is enabled, the sequencer mode LED will flash steadily. All number keys are locked out while the sequencer is enabled.

The CONT START key can be used to restart the sequencer from the point at which it was stopped.

The footswitch can be used to start the sequencer in clock modes 0, 1,5,6 & 7 and start and stop the sequencer in clock modes 2,3 & 4.

When the sequencer is started in the EXT clock modes (3,4,6,& 7) it will sit and wait for the controlling device to start before it starts itself. It is not necessary to always stop and start the SSR sequencer each time the controlling device is stopped and started unless a chain of songs are being used, in which case it may be necessary to reset the song to the first song in the chain.

Note that while it is safe to unplug the control unit cable with power on this will lock the last operating status. Reconnection with power on will reset the system to the status of mute patch '0'. If power is applied without the SSR control unit being connected then a random pattern of mutes will result. To run the system without control unit lift the 3 pin DC plug from the Automute master pcb in the right hand end of the fader bay.

SIGMA MUTE PROCESSOR SYSTEM

Introduction

MP (Mute Processor) hardware is standard equipment on all in-line Sigma consoles (M470 modules) and comprises:

- i) One MP control module M494 located in the fader area.
- ii) A computer assembly "MPC", with connections for external equipment. This is accessible when the meterbridge is open.
- iii) Mainframe wiring between the MPC and individual I/O modules, via the MPS assemblies in the fader bay.

Mainframes are prewired with MP facilities for two mutes (large and small fader) at each frame module position. Up to 128 (64 x 2) mutes can be controlled. Internal connection is made from the MP system into the audio module via a 0.1" plug and socket flying lead which can be separated for module service access. This is a five way connector and is polarised against wrong insertion.

MP hardware operates with momentary action type mute pushbuttons. Operation of M410, 420 and 430 type modules in MP mainframes requires special amendments to the modules and interfaces and will be undertaken on request.

The MP connection format to external equipment is MIDI standard, and includes MIDI IN, MIDI OUT and MIDI THRU on the normal (180 degree) 5 pin DIN sockets.

There are two levels of operation of the Sigma MP system:

- i) "Stand alone" operation without reference to external sequencer equipment.
- ii) Operation in conjunction with external sequencer equipment.

These two levels are covered, in detail, separately.

OPERATING THE MUTE PROCESSOR

The mute processor system used on in-line Sigma consoles is a more advanced form of the SSR Automute system. With the mute processor, programming of the small and large fader mutes can be carried out locally on each I/O module type M470. The mute switches are scanned by the processor system and the processor controls the audio mute elements in the modules. The MP computer memory is continuously updated every few milliseconds with the current mute status of all modules. The M494 fader panel control unit allows up to 32 complete mixer settings to be stored, recalled and edited. The mute processor has MIDI in, thru and out connections for interfacing with MIDI sequencers thus providing a sophisticated package which can be synchronised.

AHB SIGMA TECHNICAL MANUAL

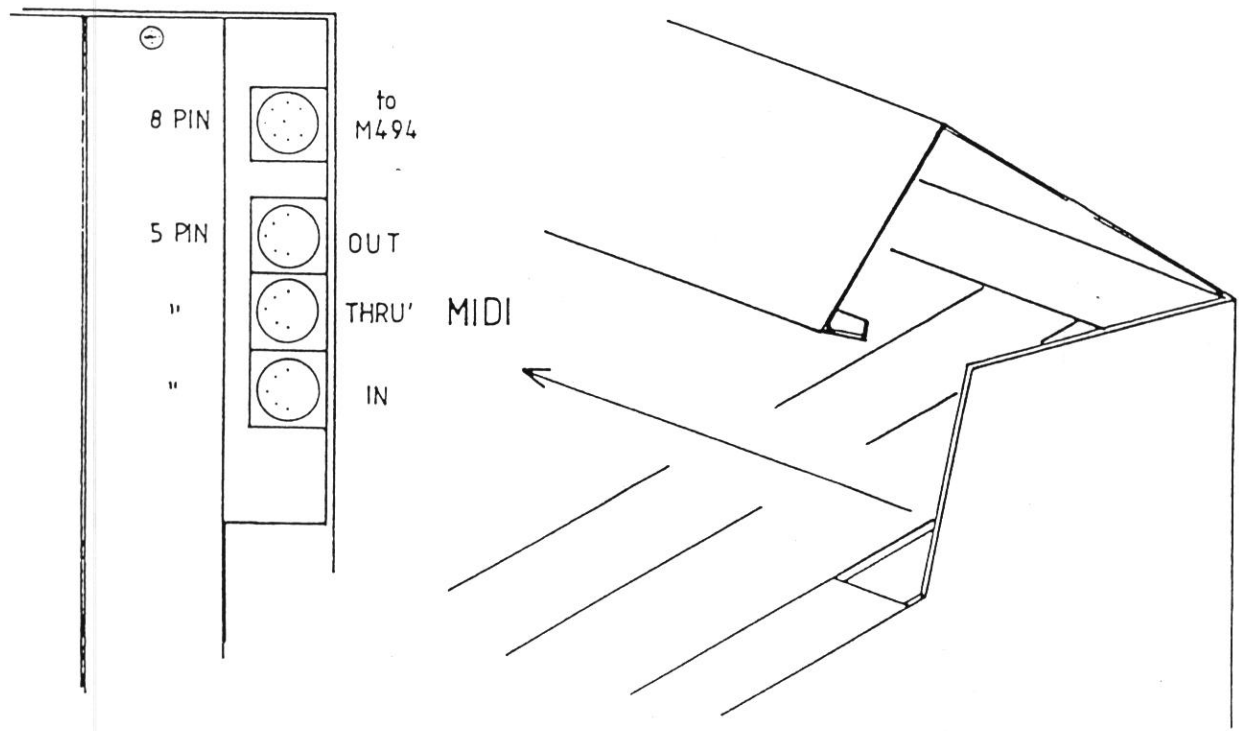
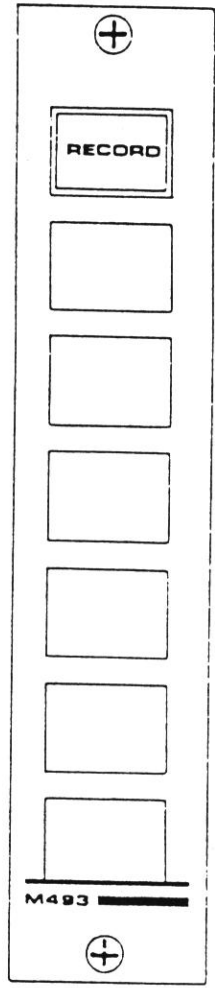
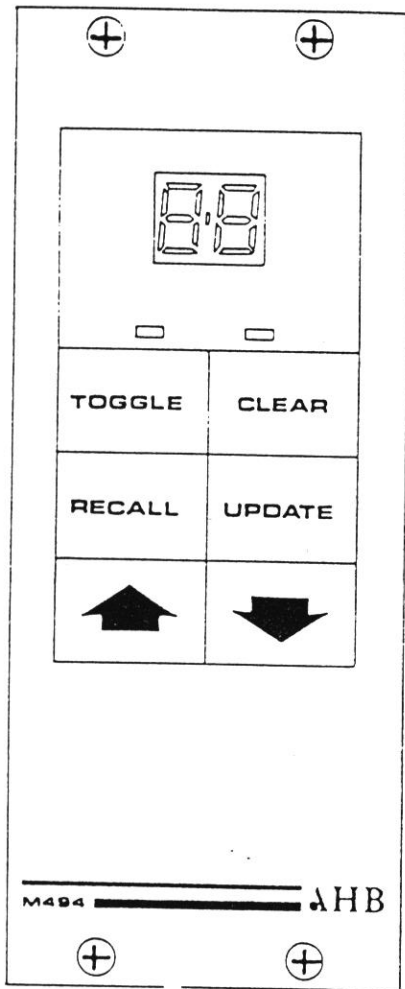

1) Stand Alone Operation

For applications where there is nothing connected to the MIDI IN socket or where MIDI control is disabled.

When the console is first turned on all mutes are open and the control panel display will indicate "16" with both LEDs on, this is the default MIDI channel number. The MIDI channel number can be changed using the up and down buttons as required. Once the required channel is set store it by pressing the UPDATE button. The display will change to show 1 (memory 1) and both LEDs go out.

Operation of mutes is immediately available in the usual fashion from the module pushbuttons. MIDI channel 16 is selected automatically as the channel most likely to be uncommitted in a typical system and therefore available for use.

Make the selection of MIDI channel your first operation. If you wish to change it later it is necessary to switch off the system then switch on again. If the MIDI channel number is unimportant to you simply store the default channel number 16 by pressing UPDATE. If your application does not call for MP facilities it can be simply left on and ignored or the 8 pin cable to the control panel disconnected within the meterbridge.

The display is now showing the mute memory numbers, any number (1-32) can be displayed using the UP and DOWN keys. The system has a working memory (0) into which, and from which, the memories 1-32 are transferred. The double action CLEAR button allows you to clear the working memory. Pressing the TOGGLE button switches the display between the last memory recalled (when the LED is lit) and the memory being pointed to by the control unit. Refer to the illustration of data flow.

Memories contain mute patterns which are the mute statuses for all the faders. These statuses will be instantly and simultaneously sent to the faders when the memory is RECALLED. To store a mute pattern in a memory, select the memory number using the ▲ and ▼ buttons and then press the UPDATE button. The contents of the memory will then be overwritten with the new data. The data can be retrieved by re-selecting the memory number and pressing the RECALL button. This method of RECALL and UPDATE allows easy editing of the mute data. To check which memory number was last recalled to reset the mutes, use the TOGGLE and note the number displayed when the LED above TOGGLE is lit.

The working memory contains the mute pattern recalled last, with the addition of any changes made since then. You may wish to compile a set of mute patterns where each succeeding memory is a refinement of the previous "mute take". This is easy to achieve since the working memory is the mute pattern recalled last.

When you are happy with a mute take store it in a memory:

- i) Select memory number, eg. 3, using UP/DOWN.
- ii) Press update. Console mute pattern is stored in memory 3.
- iii) Proceed with mute changes, these are held in the working memory.
- iv) Select memory 4 using UP ▲
- v) Press update. Console mute pattern 3 with changes is stored in memory 4.

Note that the memory can only recognise a change from on to off or from off to on. If you make two changes on the same fader mute, eg. off-on-off, this requires two memories to store it, one for each change of state.

Make a note of the cue point in the programme relating to each mute memory. When you have all the mute patterns rehearsed and stored you can achieve replay of the mute patterns under manual control. Select up the first memory and at the cue point hit RECALL. Select the next memory prior to the next cue point and when it arrives hit RECALL again. This manual procedure can be automated in sync using MIDI.

2) Using Midi

INTRODUCTION: the MP system can be connected to a MIDI sequencer using the MIDI IN and OUT sockets. This enables both individual mute changes and MP memory changes to be recorded and replayed by the sequencer.

In the description that follows it is assumed that the MP is connected in a system with MIDI multitrack sequencer that supports MIDI song position pointer and includes a MIDI/SMPTE converter synced to the music programme source, eg. multitrack machine. The MIDI operating channel was determined during console power up described above. The MIDI output of the MP system encodes every fader mute switch change. Combined with this data is the code for identity of MP memories 1-32 whenever one of these is RECALLED. The final part of MIDI output code is the auto-update sequence of snap shots of the working memory, ie. the fader mute statuses. Auto update makes it possible to "drop-in" during a piece with fader mutes correctly set for the location.

FIRST PASS: to store mute change data in the SEQUENCER first adjust the sequencer controls for RECORD mode and also select the MP system into RECORD mode using the pushbutton on the adjacent panel. Now go to the start of the piece and make the MIDI START POINT data entries as required by your sequencer/converter system. Store the console mute pattern required for the run-in and introduction as a memory, eg. 1. Now start the sequencer and programme sources followed by RECALL memory 1. Continue to make mute changes as the piece proceeds and make notes of cue points where more changes will be needed. At the end of the piece stop the sequencer and the music programme.

CHECK: check what you have done to gain familiarity and confidence. Return to the start, set the sequencer to PLAY and switch the MP out of RECORD mode. Start the sequencer and music programme. Note that memory 1 is automatically recalled and all subsequent mute events now occur under MIDI control and in sync.

REHEARSE: you may wish to listen to the programme section by section. Do this with MP in PLAY mode. When you start the sequencer MP will be updated with the correct mute settings for the location in the piece. When you want to store a mute change switch MP to RECORD. Each time you re-locate switch MP to PLAY so that the mutes are updated to the correct settings. The update process takes two seconds or less during which the fader mutes operate rapidly. At any time after this you can select RECORD mode to store further changes. While MP remains in PLAY auto update is able to reset fader mutes to agree with the last RECORD pass mute changes. If you make a mute change while in PLAY it will be cancelled by auto update. Make changes in the RECORD mode.

SECOND PASS: set the sequencer controls to replay the existing "track" of data while simultaneously recording a new track. The new track will combine previous and new data. This is called sequencer "overdub". Return to the start, select MP RECORD, sequencer OVERDUB and start the system. The first event will be memory 1 for the initial mute setting which was recorded on the first pass. You could change it by editing memory 1. As the piece progresses add further mute changes and continue to the end of the piece. Check the second pass by replaying from the beginning with the sequencer in PLAY. You should find that the second pass includes pass 1 and the additions of pass 2.

DROP IN/OUT: you may wish to save time and re-take only a small portion of the piece with mute changes. Two new operations are required:

- i) PRE ROLL: when you start the sequencer somewhere in the middle of the piece the MP requires to be updated with the mute status appropriate to the particular location. To do this MP should be selected out of the RECORD mode into PLAY mode, release the RECORD switch. Now, with the sequencer playing, the MP responds to auto update information stored with mute change data. This process requires a maximum of two seconds during which fader mutes operate in rapid succession until the MP has been updated and the fader mutes then agree with the pre-programmed status for the location chosen. Following this update period select MP into RECORD mode and then the sequencer into OVERDUB mode. Mute changes will now be written over the previous data until the sequencer is stopped. Remember, auto update is being transmitted in MP RECORD mode. In PLAY mode auto update is received, and used, for up to 2 seconds to reset the fader mutes correctly for the location in the piece.
- ii) DROP OUT: to drop out of a mute pattern record pass simply stop the sequencer. If you are going to do another drop in include two second sequencer pre-roll. Select MP PLAY mode and start pre-roll.

AHB SIGMA TECHNICAL MANUAL

DATA FLOW MUTE PROCESSOR SYSTEM

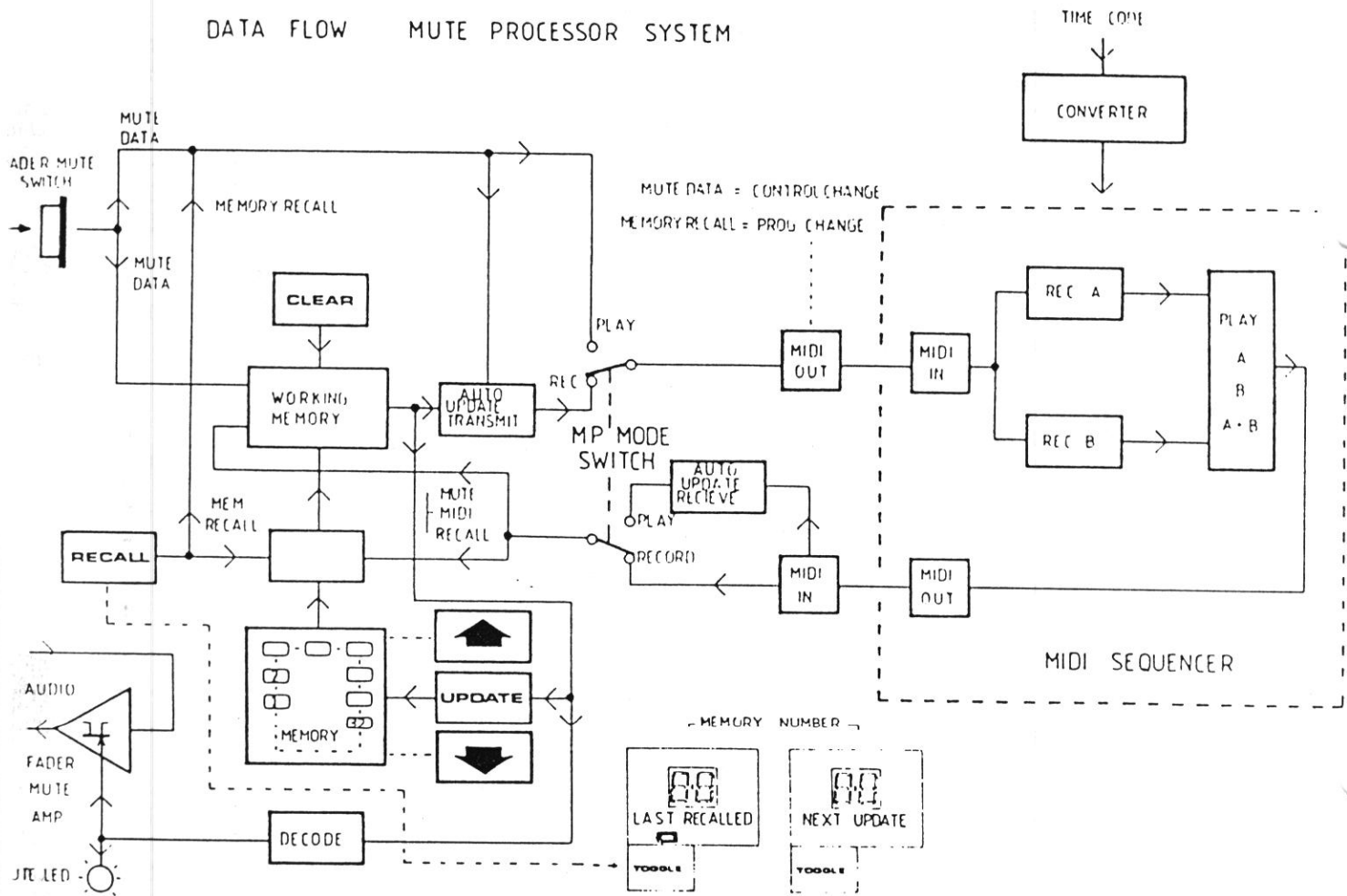

Switch to MP RECORD and sequencer OVERDUB before making mute changes. After you drop out from sequencer record mode and on the next pass the mute data will be the combination of your previous pass and the revised section. For each fader mute there may now be a conflict between the mute status at the end of the revision and the mute status as previously recorded. In this case the data from the earlier pass will cause an unwanted change of mute status. The situation is similar to an audio multitrack channel on which several passages of different programme are inserted in sequence. You have to take care to co-ordinate the time in the piece with the use of the channel. With MP drop in/out sections it is necessary to ensure that at the end of the revision the final mute status of a fader agrees with the mute status called for on the previous pass at the drop out point.

MEMORY RECALL: changes of mute pattern can be stored in MIDI by use of the memory RECALL facility. Only RECALL data is sent by MIDI. Memory UPDATE occurs only within the MP memory system and is not transmitted to MIDI. RECALL events are stored in the sequencer with data for individual fader mutes in real-time.

The contents of an MP memory is called a mute pattern. This is a snap-shot of all fader mute statuses. There are 32 memories. To create a memory at any time simply press UPDATE. The current mute status for all faders is loaded into the memory number displayed (TOGGLE LED off). Select a new memory using the up/down keys. Load the next mute pattern using UPDATE. When creating memories note the memory number, the particular cue point for it and the purpose of the pattern stored. Note that when you change memories, each can change any number of fader mutes ONCE for each fader. If you wish to create a sequence of mute events, for example on one fader, which mutes, then 10 seconds later, un-mutes, it is necessary to store this as two memories, one for each change, which are recalled in sequence and in sync. To store a sequence of mute pattern MEMORIES in the sequencer start by rehearsing the patterns, then with the system stopped enter each pattern as an MP memory using UPDATE and UP/DOWN keys as described above. In each case note the cue point, memory number and purpose.

Now restart the system in RECORD/OVERDUB. Select RECALL for each memory required at each cue point. RECALL events are transmitted to the sequencer. If you drop in or out remember to allow the sequencer the two second pre-roll period and select MP PLAY mode during pre-roll. At the end of the piece rewind and check the mute memory patterns have been stored. The MP panel display will respond showing each memory number as the changes occur and the toggle LED will light. Remember to check that following a MEMORY RECALL event and drop out manoeuvre the mute status of each fader is not contradicted by an earlier pass.

Note that you can alter a mute pattern stored in a memory and recalled by MIDI. MIDI only choses the memory number. The MP system responds and sets the console mutes to the pattern in the memory. Keep notes for each memory pattern if you expect to re-run a piece at a later date.

PLAYBACK: on conclusion of a set of mute record passes you have created a sequence of mute changes synchronised under MIDI control. Further changes can be made at any time, however, if you wish to protect the stored sequence adjust the sequencer controls to prevent over-recording the final take. The MP system continues to transmit mute change data when in the PLAY mode.

Rewind to the start, allowing for pre-roll, select MP PLAY mode and now give attention to other console controls while the MP system and sequencer run the mutes in sync. Fader mutes continue to be operational. If you decide to make further changes go into RECORD mode or auto update will reset the mute you changed so it agrees with the previous RECORD pass. Keep notes of mute memory patterns and cues with the track sheets for re-use later.

Should you wish to operate the MP system with a sequencer that does not support MIDI song position pointer then the auto update data from MP cannot be used and memory space in the sequencer is best used if MP remains in the PLAY mode continuously. Mute change and memory RECALL data continues to be transmitted. In this situation each retake must commence with return to the start of the piece in order for the previously stored mutes to be correctly set in sequence from the beginning of the programme. Drop into MP RECORD mode when the cue points for revisions are reached. If you re-start in the middle of a piece MP is unaware of which mutes were on or off prior to that point.

Sophisticated MIDI sequencers allow editing of sequences step by step which avoids the need to retake a sequence.

MIDI CODES Sigma Mute Processor version SigMB V1.0

- 1) Sigma Mute Processor transmits and receives messages coded for MIDI CHANNEL communication only according to MIDI 1.0 specification.
- 2) The MIDI channel VOICE MESSAGES subset is used.
- 3) The CHANNEL VOICE message CONTROL CHANGE has the following format which is transmitted at each mute pushbutton operation .

```

1011nnnn                0111010X                0VVVVVVVV
n, 0-15 = midi channel number.  X = 0, mute.  X = 1, not mute.  VVVVVVVV =
console channel 1-128.
    
```

These are used to operate console audio mute switches via the Mute Processor system. Each console channel has two mutes, one large, one small fader. Use your MIDI system to identify each fader number.

- 4) The CHANNEL VOICE message PROGRAM CHANGE is used:

```

1100nnnn  Opppppp = MUTE MEMORY PATTERNS 0-127.
           pppppp  representing 1-32 with wrap around.
    
```

These are used to select one of the 32 available Mute Processor memories.

- 5) Data is compressed to create the Autoupdate message.

Control change	1st data byte = console channels	2nd data byte	
		X = 1 = audio on	
		X = 0 = audio mute	
		7 6 5 4 3 2 1	
1011nnnn	0110 0000	1 - 7	0 X X X X X X X
1011nnnn	0110 0001	8 - 14	0 X X X X X X X
1011nnnn	0110 0010	15 - 21	0 X X X X X X X
1011nnnn	0110 0011	22 - 28	0 X X X X X X X
1011nnnn	0110 0100	29 - 35	0 X X X X X X X
1011nnnn	0110 0101	36 - 42	0 X X X X X X X
1011nnnn	0110 0110	43 - 49	0 X X X X X X X
1011nnnn	0110 0111	50 - 56	0 X X X X X X X
1011nnnn	0110 1000	57 - 63	0 X X X X X X X
1011nnnn	0110 1001	64 - 70	0 X X X X X X X
1011nnnn	0110 1010	71 - 77	0 X X X X X X X
1011nnnn	0110 1011	78 - 84	0 X X X X X X X
1011nnnn	0110 1100	85 - 91	0 X X X X X X X
1011nnnn	0110 1101	92 - 98	0 X X X X X X X
1011nnnn	0110 1110	99 - 105	0 X X X X X X X
1011nnnn	0110 1111	106 - 112	0 X X X X X X X
1011nnnn	0111 0000	113 - 119	0 X X X X X X X
1011nnnn	0111 0001	120 - 126	0 X X X X X X X
1011nnnn	0111 0010	127 , 128	0 X X X X X X X
1011nnnn	0111 0011	UNUSED	

MULTITRACK OPERATIONS

CONVENTIONAL GROUP FORMATS

Conventional group format consoles (M410, 420, 430 modules):

A typical console has 32 M410 modules to the left and 24 M420 modules to the right. Refer to the illustration of the typical studio system, the text that follows assumes this type of system is in use. Note that the connection system between the multitrack recorder/reproducer and the console is not limited to the variation illustrated. When the multitrack outputs are wanted on input channels type M410 as well as on monitors (M420) then exploit the signal split capability of the M410 TAPE IN/TAPE OUT connectors.

It will be helpful to have the module panel illustration unfolded and in view as a reminder of the location of the facilities described.

There are no master status controls on the present Sigma Series modules. Each module can be set up locally to create the desired operating mode.

RECORDING - the basic signal flow during recording of the first tracks is: mic and line inputs from the musicians and instruments via M410 inputs to M420 group outputs and onto tape.

As soon as tracks are laid, then these have to be monitored in the studio and control room while simultaneously further inputs are recorded onto new tracks. The monitoring function is provided by M420 and M430 modules which create a stereo mix from pre-recorded tracks for the monitor loudspeakers. This mix is the main stereo console output accessed via L-R assign switches and pan controls. Faders below the M440 module are the Left and Right master output faders. The fader below M450 is the Mono master output fader. Loudspeaker monitor controls are located centrally on the M450 panel.

INPUTS are provided by M410 for mic and line level sources. M420 provides extra return line level inputs but during record these sections are in use as monitors. The mic or line source is selected, treated with EQ as required and assigned to a track via the M420 group section and fader.

HEADPHONE cue mixes can be created from inputs using Aux controls on M410 modules and can have pre-recorded material added by using the Aux controls on M420 and M430 modules. All module types can mix into the same six Auxiliary outputs. Note that Aux 1 and 2 can be selected to be pre fader and are therefore most suitable for cue mixing. Use the CUE outputs for headphone mixes and select either the desired Aux as the source or select the L-R main monitor mix as the source. Cue outputs are in stereo and receive console talkback.

ECHO send mixes also use the six auxiliary outputs, all send controls can be post fader so there is freedom to choose any circuit(s) for echo output. Fader mute also cuts off post fader sends. Additional echo outputs can be obtained from M410 input module direct output jacks and from unused group outputs by patching. Check Cue and Echo output levels on the central light meters and listen using the PFL/AFL system.

ECHO RETURNS from effects devices can be brought into the console via M410 line or tape inputs, M420 and M430 return inputs and to the M440 Return 1 and 2 inputs. Echo wanted on Aux mixes should be sent to the aux system via send pots and echo wanted on the monitor mix should be assigned and panned L-R. Echo wanted on the group outputs should be assigned and panned accordingly. Return inputs 1 and 2 are not muted by the SOLO system.

PFL/AFL system controls allow any source or combination of sources to be checked on speakers and main meters without disturbing the current record settings. PFL is pre-fader in central mono. AFL is post fader and pan, in stereo, and is muted by fader mute.

SOLO MUTE system controls allow muting of unwanted sources by operation of the pushbutton on the wanted source. The mutes which respond are M410 input fader mute, M420 monitor fader mute and M430 monitor level mutes. M420 group fader mute is not part of the SOLO system. Used in conjunction with the master ENABLE buttons on the M450 modules it is possible to pre programme selections of mutes which will occur when ENABLE is pressed. Input and monitor section SOLOs can be controlled separately as a precaution against accidental input mute during a take.

AHB SSR AUTOMUTE is programmeable to operate the same mutes as the SOLO system. This facility has maximum potential during remix operations as an aid to fader mute operation though it can be operated at any time. A full description of the Automute operation occupies section 9 of this manual.

Signal processing devices can be patched into the audio path as needed at module insert points. On M410 inputs M420 monitors and M430 monitors these are post input gain, before equaliser and fader. On group outputs the insert points are pre-fader. The main stereo mix Left and Right insert points are also pre-fader. Auxiliary outputs 1 and 2 also have insert points after the mix amp stage and before the master level control.

TALKBACK can be addressed to the CUE outputs, SLATE, group outputs 1-24 and the main stereo mix. Select the combination of destinations as desired on the M450 module. Operation of the TALK key initiates talkback. The console includes a jack socket for connection of a second TALK key, refer to the SYSTEM CHECKOUT 10.8 section for details. Reverse talkback can take place through the M450 circuits from a remote microphone. Reverse talkback puts the incoming speech on the loudspeaker monitor output. Reverse talkback is initiated when talk to CUE is in progress. Refer to the SYSTEM CHECKOUT 10.8 section for details of how to install and connect the remote microphone. During talkback to SLATE a 30Hz tone at approximately -20dB is superimposed on the speech and reaches all group outputs.

OVERDUBBING AND TRACK BOUNCING

During these stages the number of pre-recorded tracks is increasing, live sources continue to be recorded and mixed as described above and each track recorded is then set up in the monitor mix.

Controls on modules M420 and M430 are operated to select the TAPE source for the monitor as each track is recorded. If your multitrack machine gives back input in SYNC and RECORD modes then this switch can be left selected TAPE all the time. The meter will show the corresponding signal level to or from tape.

The monitor facilities on M420 modules are identical to the input M410 modules (except mic in is omitted) so full EQ aux send and assign functions are available on the right hand side of the desk.

We recommend that once a track is laid then fader reverse is selected so you balance the track in the monitor mix on the large fader using the controls located above the fader reverse switch. The small fader remains in use as the group output fader. Engineers familiar with In Line type consoles may chose to work the group modules in fader reverse all the time.

M430 modules include two group outputs and two monitor sections. Monitor level is the inner control above PAN and is exchanged with the large fader in fader reverse mode. M430 modules do not include the full assign section found on inputs and M420s.

In systems having M430 outputs you will want to overdub on these monitors but track bouncing will require the tracks to be available on input M410 modules.

During bouncing (track reduction) groups of tracks are remixed through faders and assign sections to one or two new tracks. Whether this is done using input sections or M420 monitor sections the procedure is the same. In the assign section select the new track number(s) required and use pan to chose odd or even tracks.

If the bounce is in stereo leave the pan set as it is, left will go to odd tracks, right to even. On the monitors of the new tracks assign the fader to the stereo mix (L-R) and de-select the L-R assign on the source modules. Now use monitor pan to recreate the blend in the monitor mix from the blended new tracks.

When the bounce is complete send echo and cue from the monitor section of the new track. Do not wipe the old tracks until you are satisfied with the quality of the new blend. Plan track bounces in advance so that you are able to find vacant tracks when needed.

RE MIXING

The basic signal flow during remix is pre recorded sources via inputs and monitors to the main stereo output which is now used as the master record output in stereo and mono as required. Left and Right faders are the record output master faders. The mono output is the sum of Left and Right outputs.

In addition to pre-recorded material the stereo mix will include echo returns, subgroups of inputs and additional live inputs as circumstances demand.

Headphone and Echo mixes can be created using the Aux system familiar from the earlier steps. The control room loudspeaker controls on the M450 panel include source select of output to, or playback from, the master recorder and level controls for two sets of speakers.

SOLO, SSR Automute and fader automation systems can now be used as creative tools to select sources to be muted and faded in combination of manual control and automatic sequencing in synchrony with the pre recorded material.

The variety of signal routes into the mix is summarised as follows:

Inputs with EQ and aux send: M410, M420 and M430 all used as needed
Large faders assigned to the L-R mix.

Inputs via subgroups to the mix: M410 and M420 assigned to the desired group.
Group fader (small or large) assigned to the L-R mix.

Note that M420 group sections include PAN and PAN ON controls which allow the group output to be added to the mix leaving the monitor section available as an input to the mix. Also note that if a subgroup to the mix requires cue or echo send you can select group as the monitor source then use the monitor fader pan assign, aux etc to control subgroup sends.

EQ can be selected to be either in the group or monitor path (420 only).

Echo Return inputs to the mix: Use M440 Returns 1 and 2 for returns without EQ and fader. These do not respond to the SOLO mute system and so remain open during SOLO passages.

Echo Return inputs to the mix with EQ, aux send and fader may use any available M410 input or M420/430 monitor section.

While the main stereo mix is in use as the record output you may wish to create a loudspeaker mix which contains additional sources. In these cases select loudspeaker source CUE 1 or 2.

On the CUE circuit, select source L-R mix and Aux 1 or 2. The CUE output is now the L-R record output plus anything mixed in from Aux 1 and 2. This is heard in the control room speakers in stereo.

This has been only a brief summary of operations, also study sections 5 and 7 for full details.

MULTITRACK SYSTEM: AHB SIGMA

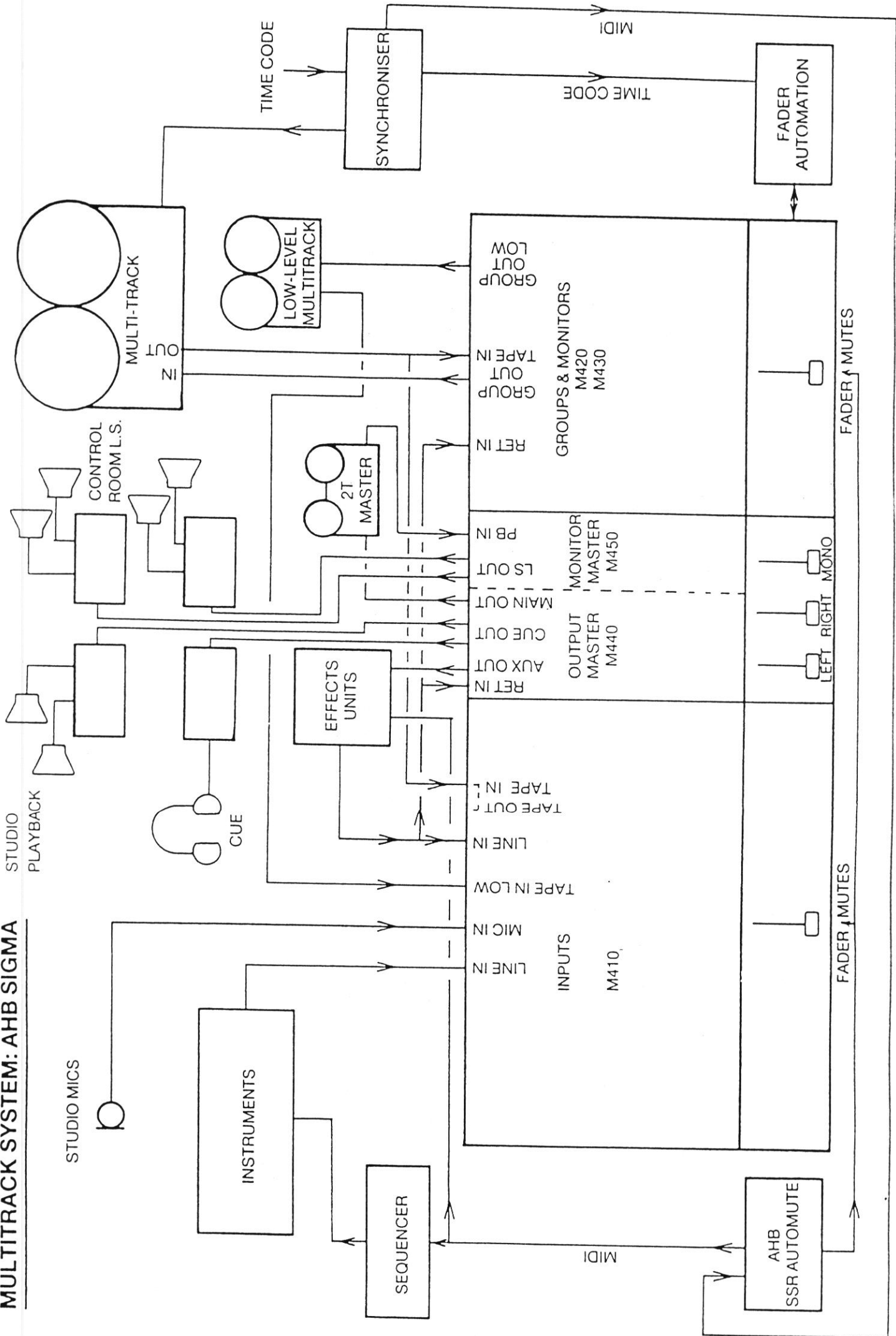

IN LINE MULTITRACK OPERATION

Introduction

The principals of operation of the Sigma In-Line system are as follows, panel controls are illustrated on a separate sheet. There is also a block diagram of signal flow. Circuit details are in section 12.

The console architecture is 24 bus with up to 32 track meters. The present maximum module capacity is 56 M470 type. This gives 56 equalised and 56 non equalised simultaneous inputs to the stereo mix. 16, 24, 32 and 48 track operations can be accomplished.

In front of the M441 master module are the STEREO MIX (red) and MONO MIX (white) master faders which control the console stereo and mono outputs.

The loudspeaker level controls are on the M451 master module. The stereo mix is used to listen to (monitor) the multitrack during record, overdub and track bouncing sessions. This is called the stereo monitor mix or just the mix. When recording is complete the stereo mix is used as the stereo output to the master recorder. A mono mix is also available from the stereo mix. There are 24 bus outputs for multitrack recorders and 8 auxiliary mixes for cue and echo.

M470 I/O modules perform all functions for input, bus output, monitoring of the multitrack and subgrouping. Fader automation is available. All I/O M470 modules carry two faders and pan pots. These are dual purpose and can both be connected to the stereo mix. During RECORD sessions the row of small faders are used to control the live inputs being recorded on tracks. The large faders are used to control the monitor level of each track in the stereo mix. Echo returns use spare large and small faders.

Adjustment of the bus output level to the multitrack is accomplished with the rotary BUS TRIM controls. When a group output fader is required, on non-automated consoles, the large fader monitors a "dummy" bus output and is then re-assigned to the required bus output.

During TRACK BOUNCE the large faders remain in use as monitors, now assigned to bus outputs for re-recording. The small faders are used as additional inputs to the mix and for inputs to new tracks.

During REMIX sessions all faders can be used to control inputs to the stereo mix. Tracks use the first 24 large faders (or 31 or 46.): live inputs and echo returns use spare large faders and small faders; subgrouping of faders to the stereo mix is accomplished, on non-automated consoles, by used of spare large faders or switching the function of small faders using the "BUS" source option. The description above is the "normal" operating mode. The small and large fader functions are reversed with the SOURCE REVERSE switch on each module to give control of the live input to the large fader.

The terms "monitor" and "input" used above refer to functions which the module hardware has been designed to perform with ergonomic efficiency, that is, minimum operator effort.

The same high technical standard of performance is achieved by all signal paths, a "monitor" is equal in performance to a "bus output" and an "input". For this reason the module may be operated in a number of different ways each giving the same high technical standard but different ergonomic and signal routing qualities.

The master module set M441 M451 includes facilities for aux output, metering, talkback and loudspeaker control.

AHB SIGMA MULTITRACK SYSTEM

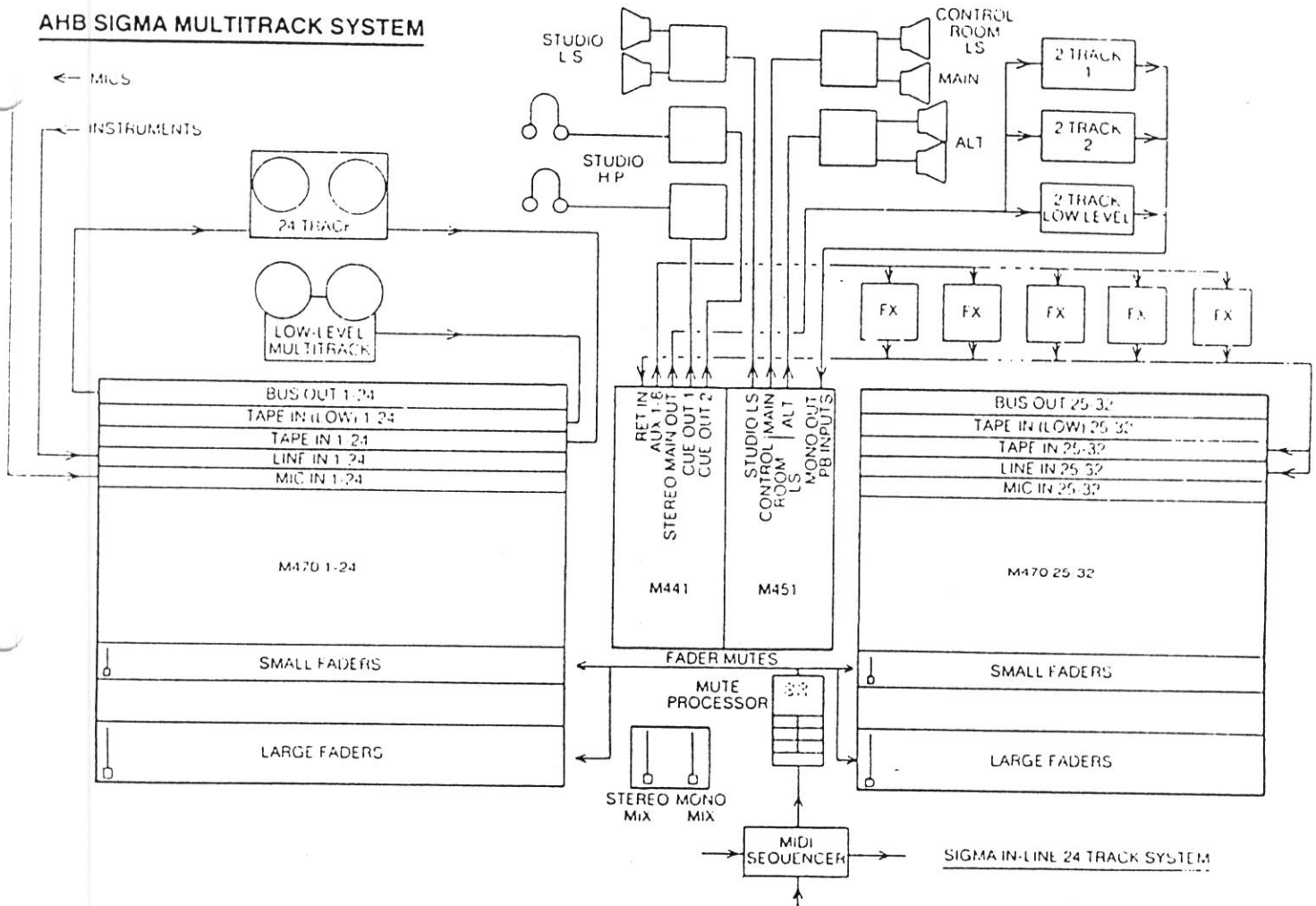

AN OVERVIEW OF THE IN-LINE M470 MODULE OPERATING SYSTEM

An In-Line Sigma console is capable of rapid ergonomically efficient multitrack record and remix operations giving excellent sonic quality results. There are no STATUS modes for the module set, each module is controlled locally. Each I/O module includes these functional signal blocks which are connected differently as the panel controls are selected, refer to the M470 schematic diagram.

Controls which affect each fader are grouped nearby. All the controls between the bottom of the small fader and the top of the large fader are large fader controls. The small fader controls are alongside it and small fader pan is above the small fader.

- INPUT for live material from MIC and LINE sources, includes gain controls. Line can be used for instruments, it is NOT the multitrack source.
- BUS OUTPUT the mixed sum of sources ASSIGNED to the 24 output buses. BUS TRIM provides output level adjustment.
- MONITOR INPUT input with gain control for either the output to or return from the multitrack. Normally used to balance the track in the stereo mix. The source is determined by the BUS/TAPE pushbutton selector. The track meter source also is selected with this pushbutton.
- SMALL FADER with associated PAN, MUTE, SOLO, PFL/AFL controls is able to function either as an INPUT fader controlling the MIC or LINE input; or as a MONITOR fader controlling the BUS/TAPE monitor source.
- LARGE FADER with associated PAN, MUTE, SOLE, PFL/AFL controls is able to function either as a MONITOR fader for the BUS/TAPE monitor source; or as an INPUT fader controlling the MIC or LINE input.
- ASSIGN the selector switches which connect a fader to a BUS OUTPUT. The associated ASSIGN SHIFT switch selects either outputs 1-12 or 13-24. The associated SMALL/LARGE switch connects the ASSIGN section either to the SMALL or LARGE fader.
- EQUALISER this is a five band equaliser having cut and boost facility and is switched to the SMALL or LARGE fader as required. PHASE REVERSE and PEAK LED move with the EQUALISER.
- AUX SEND outputs on four dual concentric controls to eight auxiliary mixes. Selector switches put the AUX SENDS in the small or large fader sections as required.

Some controls which are unique to Sigma and may not be self explanatory:

SOURCE REVERSE a major status switch for the module. When selected connects the MIC/LINE input to the LARGE FADER and the BUS/TAPE monitor source to the SMALL FADER.

MIX when selected connects the SMALL FADER pan output to the STEREO MIX.

MIX MUTE when selected disconnects the LARGE FADER pan output from the STEREO MIX.

PFL/AFL checking system which uses the loudspeakers and meters only and does not affect the bus output or stereo output systems. PFL is central mono pre fader listen. AFL is panned stereo after fader listen. There are associated operating mode controls on the M451 master module.

FOLLOW LARGE this is a small fader function selector having two possible modes of operation: **NORMAL MODE** (plain grey button) when selected, the small fader is connected to receive the large fader output. When all aux sends are used up this allows the small fader to operate as an echo send fader via the assign section to bus outputs, which are patched to the echo device as required. **BUS MODE** (legended grey button) an internal link option is selected. Now when the pushbutton is selected the small fader is connected to receive the bus output signal. This accomplishes a subgroup fader of any faders assigned to that bus. The subgroup fader may be re-assigned and/or switched to the stereo mix.

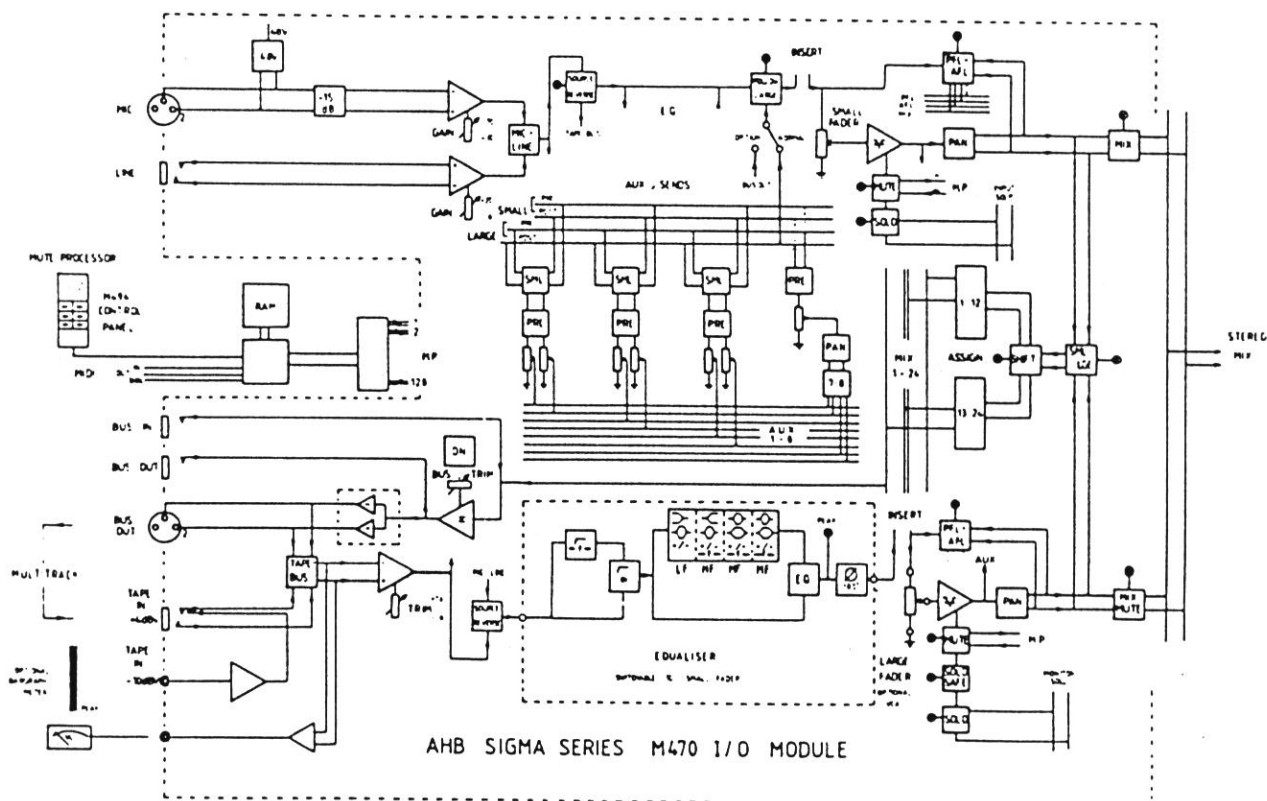

GENERAL

The description which follows is applicable to a standard format In Line console installed as part of a 24 track recording operation. The module complement typically is: 32 M470 I/O modules, 24 track metering, the M441 and M451 master module set and standard non VCA faders. The main stereo output is used for monitoring during record and also for the master mix during remix sessions.

SET-UP

Refer to the illustration of the M470 module which shows control locations and descriptions. There is no "status" switch system for the complete console. Prepare the console for operation by resetting all controls to "neutral" as follows:

Pushbutton switches	released
Mic gain (dual conc)	centre
Line gain (dual conc)	centre
Bus trim	centre
Aux level 1-6 (dual conc)	off, anticlockwise
Aux level and pan 1-2/7-8	inner off, outer centre
Eq top sections	centre
Eq outer sections	doesn't matter
Small pan	centre
Large pan	centre
Faders	off

The master module set M441/M451 should also be reset as follows:

All pushbuttons released except "STEREO MIX" which should be selected for C R Monitor loudspeakers.

Returns 1 & 2 aux	off
level	off
pan	centre
Aux master 1 to 8	0dB
Cue output 1 & 2	0dB
Faders L & R (or stereo)	0dB
Mono	0dB
Alternate LS level	adjust for listening level
Main LS level	adjust for listening level
PFL/AFL master level	0dB
Headphone monitor level	adjust for listening level
Talkback level	adjust for speech level

Clear the patchbay of overplugged circuits.

Set Mute Processor system to CLEAR the working memory.

Press CLEAR twice. and stop any MIDI based sequencers connected to the Mute Processor.

Set fader automation. if fitted. to the WRITE mode.

Check the meterbridge DC status indicators are all on and equal brightness.

Check PFL/AFL, SOLO MON and SOLO INPUT status indicators are off.

OPERATING TECHNIQUES

These descriptions follow the sequence of a typical session from record to remix. In order to keep the text brief operations are divided up and given headings.

IMPORTANT the descriptions assume the console has been reset as described earlier with all PUSHBUTTONS RELEASED and rotary controls reset.

RECORDING

- 1) Concentrate on one I/O module to which your microphone/instrument, and the multitrack, are connected.
- 2) Operate control 12 to select MIC or LINE input to the SMALL FADER.
- 3) Operate controls 17 to ASSIGN the small fader to the required track. Use the small fader PAN control 48 to select one of the two tracks. If you want a track in the sequence 13 to 24 then first select control 18 SHIFT.
- 4) Open the SMALL FADER 54 to the "0" position. Watch the console meter for the track you assigned to. This is showing outgoing signal level to the multitrack. Adjust controls 16 to vary the mic or line GAIN so that normal meter indication is present.
- 5) Assign any number of "inputs" to the record output. Go to the module number of the track you assigned to, this is the "monitor" module. Open the LARGE FADER to the "0" position.

Watch the console L/R meters. These show the outgoing signal level to the stereo master recorder. Adjust control 57 to vary the GAIN so that normal L/R meter indication is present. Adjust control 61 PAN to set the programme position in the STEREO MIX. Adjust the LS controls for a comfortable listening level.

- 6) If you want to EQUALISE the input material go back to the "input" module and select 47. EQ ON. Operate controls 34 to 46 for the sound you want. Note the status indicator 55 EQ LGE is not lit. The eq is in the small fader circuit until you select 36 eq lge. then the status LED will light and the eq is switched to the large fader circuit. PEAK LED 40. lights when the eq output is within 3dB of overload.
- 7) INSERTION POINTS are available for each small fader and are located post EQ pre fader. INSERTION POINTS are available for each large fader and are also located post EQ pre fader.

This completes the signal path: INPUT → ASSIGN → BUS OUTPUT → MONITOR → MIX. There is no group output fader in use. The small fader is input, the large fader is monitor. To make adjustments to the outgoing record level use BUS TRIM 20, 21. Most multitrack machine outputs automatically switch to line-in mode during READY, RECORD and STOP. In this case you can select monitor mode TAPE, 56, at the start of the session and leave it so.

EQUALISATION

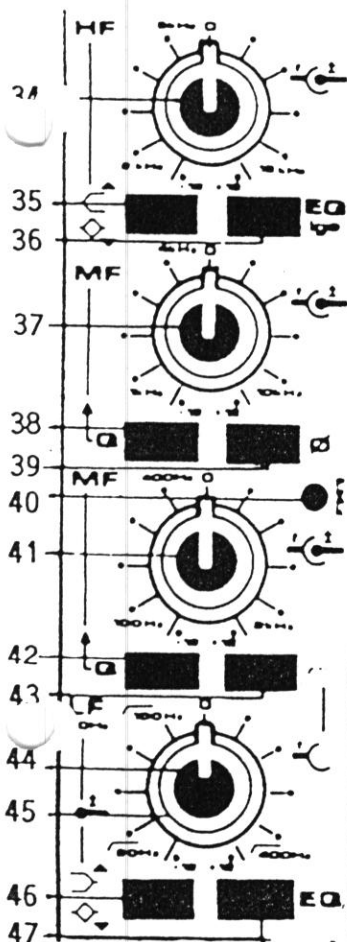

- 34. HF equaliser: shelving or bell characteristics between 2kHz and 16kHz with 12dB infinitely variable cut and boost on the inner control, frequency selection on the outer control.
- 35. Select HF shelf or bell characteristics. Normally shelving curve, when pressed gives a peak/dip (bell) curve characteristics to HF equaliser. Bell Q = 0.7.
- 36. Places EQ section in the large fader signal path. Controls 39 and 40 also are switched with the equaliser to the large fader.
- 37. MF equaliser peak/dip (bell) curve equaliser operating between 1kHz to 10kHz with 12dB infinitely variable cut and boost on the inner control and frequency selection on the outer control.
- 38. MF Q is normally 0.6 and can be sharpened to 2.5 with the pushbutton.
- 39. EQ phase reversal select. Phase reverse switch. inverts signal phase of the programme being equalised.
- 40. Peak indicator responds to EQ output level and lights when 3dB headroom remains.
- 41. MF equaliser. peak/dip (bell) curve equaliser operating between 100Hz to 2kHz with 12dB infinitely variable cut and boost on the inner control and frequency selection on the outer control.
- 42. MF Q is normally 0.6 and can be sharpened to 2.5 with the pushbutton.
- 43. Press to select rumble filter, 12dB/octave slope. Cut off frequency is adjustable with control 45.
- 44. LF equaliser; dual concentric inner control give 12dB continuously variable cut or boost with shelving or bell characteristic at 90Hz frequency.
- 45. Dual concentric outer section adjusts rumble filter cut off frequency between 20Hz and 400Hz.
- 46. Select bell or shelf characteristic for the LF equaliser. Bell Q = 1.6.
- 47. EQ switch, press for equalisation. Phase reverse and rumble filter are independant from the EQ in/out selector.

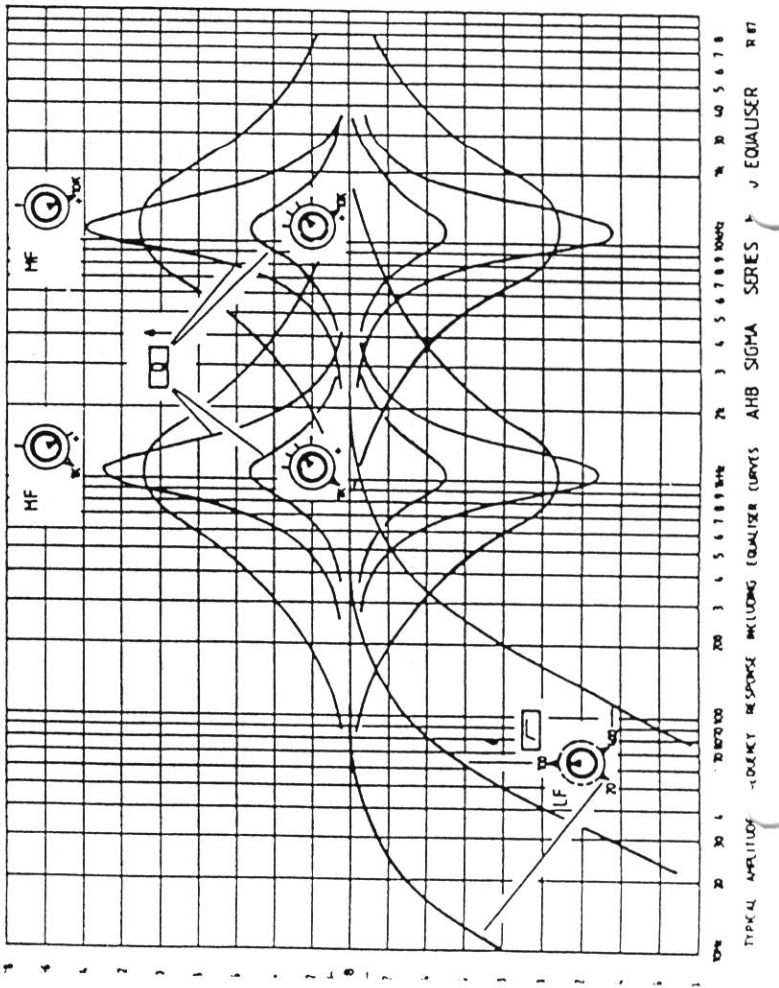
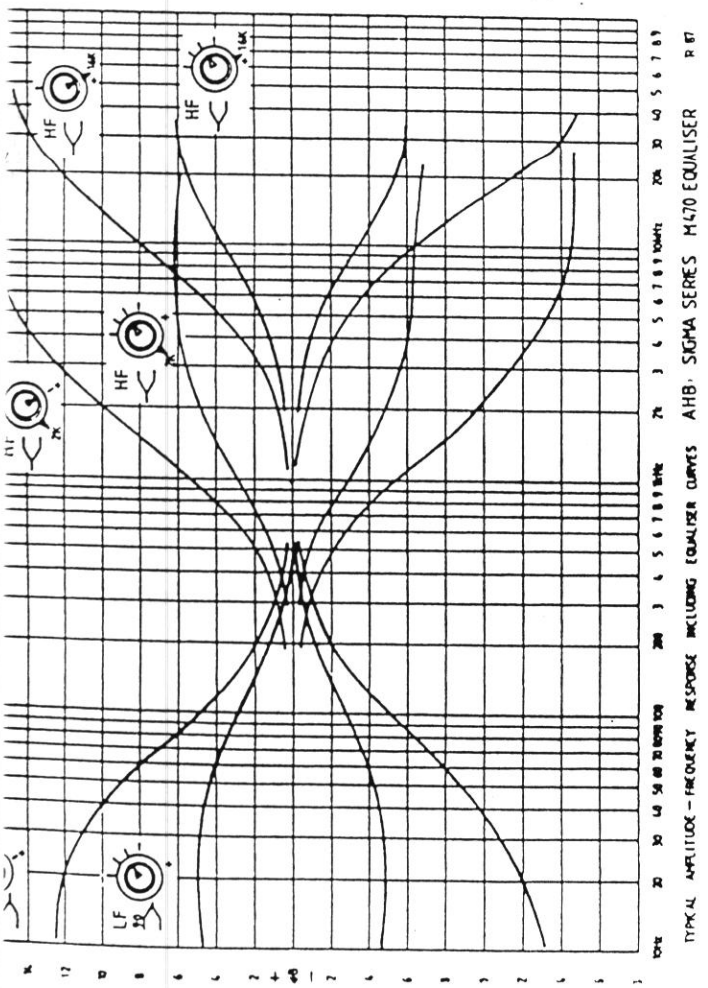
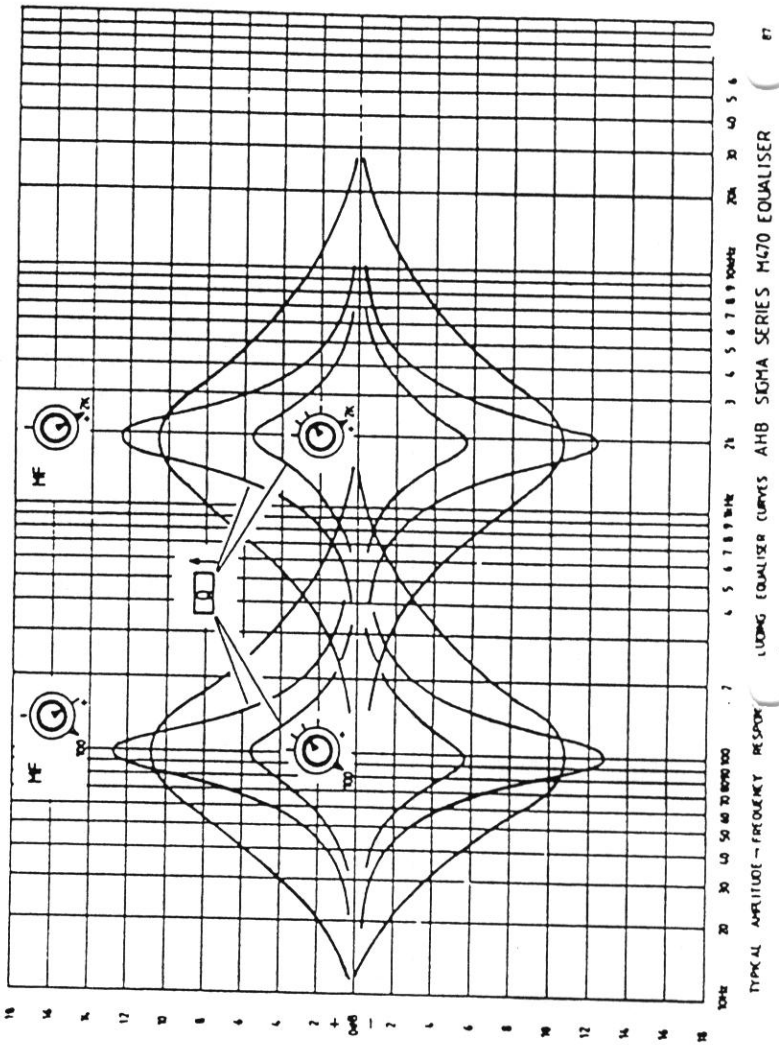
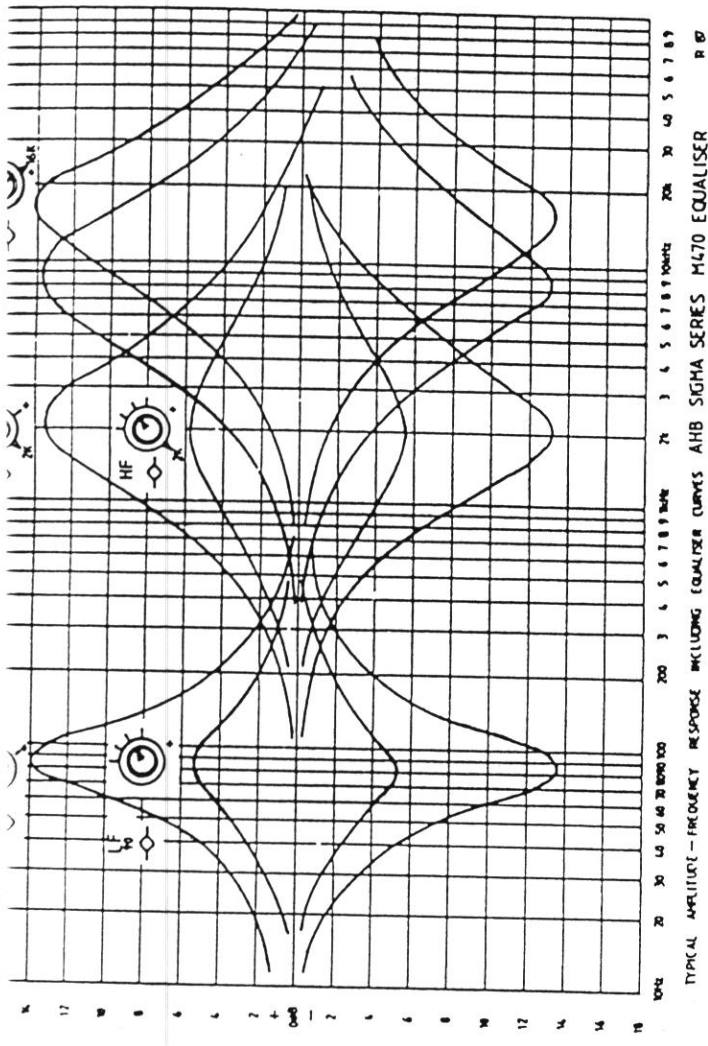

OVERDUB

You want to hear the pre-recorded tracks in the stereo mix and record new tracks.

- 1) On modules corresponding to pre-recorded tracks select TAPE monitor mode with pushbutton 56. Your large fader and pan now control the multitrack output which is heard in the mix.
- 2) The meter is showing incoming level off-tape.
- 3) To eq the track select eq lge, 36, and eq on, 47. The PEAK indicator, 40 and PHASE REVERSE control, 39, are in the same fader circuit as the eq.
- 4) You can use the rest of the module as an input section for further tracks.

TRACK BOUNCE (track reduction)

Mono Bounce

You want to mix five individual tracks down to one mono track.

- 1) Go to the source track modules. Select ASSIGN LGE 19. Select ASSIGN pushbutton corresponding to the destination track, using SHIFT to reach tracks 13-24. Operate the large pan pot, 61, to select one of the two tracks selected by the pushbutton.
- 2) On the source track modules select MIX MUTE, 58. This cuts the track from the mix to prevent double mixing.
- 3) On the destination track module open the large fader. You may have TAPE or BUS source selected. This is the monitor for the new track. Use the large pan pot to set the stereo image.
- 4) Check the new track meter. If the level is high or low use BUS TRIM 20, 21 on the destination track module to adjust the outgoing level up or down. This completes the signal path TRACK → ASSIGN → BUS OUTPUT → MONITOR → MIX.

Stereo Bounce

You want to mix four stereo track pairs down to a STEREO pair. This stereo pair will be a number pair shown on the ASSIGN pushbutton switches, ie. 1-2, 11-12, 17-18, etc and LEFT corresponds with ODD numbers.

- 1) Go to the source track modules. Select ASSIGN LGE, 19. Select the required ASSIGN pushbutton for the new destination track pair.
- 2) Leave the LARGE PAN pots where they are. Select MIX MUTE 58.

- 3) Go to the destination track module pair. Open the large faders. Turn the odd number LARGE PAN to LEFT and the even number to RIGHT. You now have two faders giving control of monitor level for the new track pair. The stereo balance is set on the source module pan pots and is as it was, set during the rehearse passes.
- 4) Check the meters for the new track pair. If the level is low or high use BUS TRIM 20, 21 on the destination track module pair, to adjust the outgoing level up or down.

At the conclusion of the track bounce record pass check the playback with the source modules muted, 62. Select TAPE source, 56, on the new tracks (or tracks) module to hear the new track output. When you are satisfied wipe the source tracks and reset the source track modules: CANCEL ASSIGN, BUS TRIM, MIX MUTE, etc in readiness for new material and MONITOR operation of the modules.

REMIX

You want all the pre-recorded material mixed with echo returns, and probably some "live" material, to create a master stereo mix which will be recorded.

- 1) Go to the modules associated with the multitrack. To hear playback select TAPE source (56) the programme is immediately available on the large fader and associated controls.
- 2) Check levels. The track meters are now showing incoming level from the multitrack. Adjust gain trim control 57 if the input is high or low and also if you want to start off with a "straight-line" fader setting.
- 3) Echo returns and "live" inputs on small faders are added to the mix using the pushbutton MIX, 50. The small fader PAN, 48, now sets the small fader stereo position.
- 4) Select eq to the small or large fader as required using the pushbutton 36.
- 5) In a 24 track system modules 25 and higher are used as echo returns and additional "live" inputs. Programme connected to the TAPE IN circuit is selected on the large fader using pushbutton 56. Mic and Line inputs are available on the small fader, also select MIX, 50. You can operate in source reverse mode, 15, at any time.
- 6) In addition to the 8 auxiliary send mixes used for echo send the bus outputs can be patched to echo devices. This facility is streamlined by the small fader "FOLLOW LARGE" selector, 49. You have a track on the large fader and need another echo send. Select FOLLOW LARGE, ASSIGN SMALL (release 19) and use the ASSIGN pushbuttons to route the small fader to a bus output. Use the small PAN pot to chose one or two of the buses selected. The small fader is receiving equalised track from the large post fader circuit. You now have echo send on a fader with MUTE, SOLO and Mute Processor.
- 7) A description of grouping and subgrouping techniques is given later on.

SOLO, MUTE AND THE MUTE PROCESSOR

These systems have control over fader mutes. When a fader is muted post fader auxiliaries, assign and pan outputs are muted.

SOLO

The SOLO system has two sub systems - small fader (INPUT) and large fader (MONITOR) solos. To use either system first pre-select the ENABLE pushbuttons on the M451 module.

- 1) Select large fader SOLO, 63. Note all other large fader MUTE LEDs respond. All large faders except the SOLO fader have been muted. Now select, on a muted fader, the SOLO SAFE pushbutton 60. This fader immediately de-mutes. Now cancel the original fader SOLO. Note that all faders now de-mute. On the fader which is SOLO SAFE select SOLO. Note all faders except this one now mute again. SOLO SAFE prevents the fader from receiving a SOLO MUTE command and leaves the SOLO switch for that fader ACTIVE.
- 2) Select small fader SOLO, 52. Note all other small fader MUTE LEDs respond. All small faders except the SOLO fader have been muted. The small fader does not have the SOLO SAFE facility.
- 3) During RECORD sessions use the master ENABLE pushbuttons to avoid accidental mute of a live input during a take.

The meterbridge include two SOLO STATUS indicators SOLO INPUT (small fader) and SOLO MONITOR (large faders) which illuminate when a SOLO is in force. The master solo switches include the SOLO LINK pushbutton which combines small and large fader solos. There are five possible modes of operation:

ENABLE INPUT SOLO	ENABLE INPUT SOLO + LINK	ENABLE BOTH SOLOS + LINK
ENABLE MONITOR SOLO	ENABLE MONITOR SOLO + LINK	

The creative possibilities of SOLO, SOLO SAFE, SOLO LINK and various echo return routings are worth experiment to reveal all the variations.

MUTE

Each small and large fader has a mute pushbutton 53 and 62. Operation of a MUTE cuts off post fader auxiliaries assign and pan outputs. All M470 fader mutes are part of the Mute Processor System. A mute can occur for three reasons:

- 1) Local mute: operation of the module pushbuttons
- 2) Solo mute: in response to a console solo operation
- 3) Mute Processor mute: operation of the fader mutes by the Mute Processor system.

In all cases the result is the same:

Audio on = Mute LED off

Audio mute = Mute LED on.

MUTE PROCESSOR

This permits memory storage and recall of mutes and sequences of mutes with synchronisation. Full operating instructions are included in Section 9.

In order to be familiar with the basic MP operation make the following quick test using the M494 panel controls.

- 1) If the console has just been powered up press UPDATE. If not turn off the TOGGLE LED using the TOGGLE key and STOP any associated MIDI sequencers.
- 2) Use ▲ ▼ to select MP memory 1. Press CLEAR to de-mute all faders.
- 3) Press UPDATE to store "no-mutes" in memory 1.
- 4) Use ▲ to select memory 2. Set mutes on any faders using the local pushbuttons. Press UPDATE to store "mute only faders 'n'" in memory 2.
- 5) Use ▼ to select memory 1. Press RECALL. Note all mutes clear.
- 6) Use ▲ to select memory 2. Press RECALL. Note the mute pattern is reinstated.

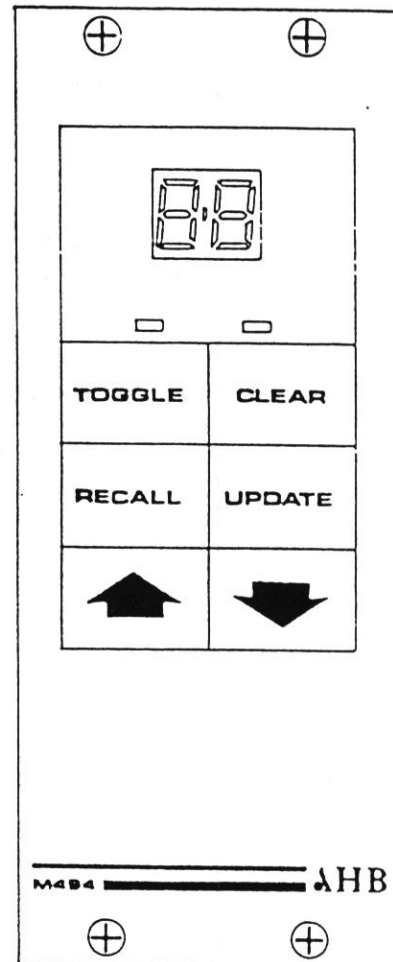

GROUPING AND SUBGROUPING

This description assumes the console has non-automated faders. When fader automation is fitted grouping versatility will be increased. The operating modes described give the large fader to the "monitor" function and small fader to the "input" function, check that SOURCE REVERSE (15) is released.

Grouping on bus outputs

When sources are assigned to BUS OUTPUTS the BUS TRIM rotary control (20, 21) provides a degree of level control for the mixed output in the multitrack. BUS TRIM only operates when pushbutton BUS TRIM ON has been selected.

The M470 module system allows faders to receive the BUS OUTPUT signal and re-assign it to another bus output. There is no arrangement which allows the faders on a module to control the BUS OUTPUT of the same module directly. ie. the module XLR output signal cannot be interrupted using panel controls to place a fader before the output connector..

SMALL FADERS can be used to control a group of inputs and re-assigned to another bus output. Chose a small fader that is not required as an input itself. Assign the required inputs to it. Now re-assign the small group fader to the required bus output. Monitor the final bus output using the large fader on the module corresponding to the track being recorded. This description assumes the small fader "FOLLOW LARGE/BUS" OPTION has been installed. Refer to Section 10, page 10.9.

LARGE FADERS can be used to control a group of inputs. Chose a large fader not required as a monitor fader. Assign the required inputs to the bus output having the same number as the chosen fader. Select BUS SOURCE by releasing pushbutton 56. Now re-assign the large fader to the required bus output and track, select ASSIGN LGE, 19, and use pushbuttons 17. Monitor the final bus output using the large fader on the module corresponding to the track being recorded.

In all cases auxiliary sends, mute, etc are operational on the chosen group fader. Note that SOLO of a group fader may be self defeating.

SUBGROUPING TO THE STEREO MIX

Each M470 has two signal routes into the mix; large fader and small fader.

LARGE FADER - method 1

The large fader source select, 56, includes the BUS OUTPUT source. When sourcing BUS OUTPUT the first 24 large faders therefore perform the function of subgroup faders for all sources assigned to bus outputs. Use large pan pot 61.

LARGE FADER - method 2

Since the first 24 large faders are in use during REMIX as track monitor faders a facility is provided which allows faders 25 and higher to be subgroup faders to the mix. On the module connector area use a 1/4 inch jack to jack cable to patch BUS OUT jacks, from the first eight modules for example, into BUS IN jacks on modules 25-32. Now select BUS SOURCE (56) on modules 25-32. The first eight BUS OUTPUTS are now available on large faders 25-32 for mixing. Use large pan pots 61.

Module 25

Module 1

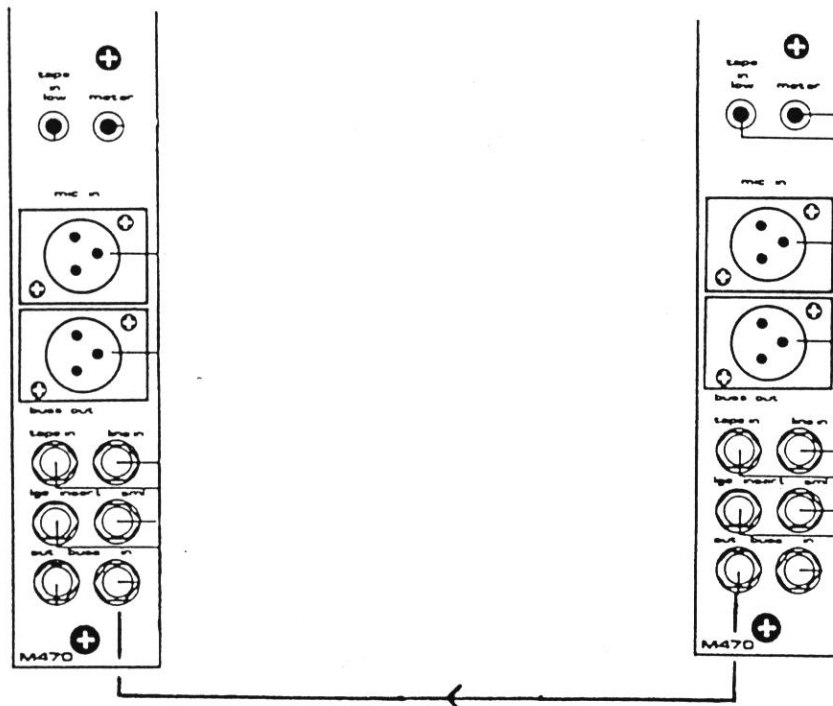

LARGE FADER - method 3

Use the console PATCHBAY to connect a BUS OUTPUT to a SPARE LARGE FADER INSERT RETURN.

SMALL FADER - method 1

At any time use the console PATCHBAY to connect a BUS OUTPUT to a SMALL FADER INSERT RETURN. The small fader must then be assigned to the MIX using pushbutton 50. Use small pan pot 48 to set the image position.

SMALL FADER - method 2

The M470 module assembly includes an alternative option for the operation of pushbutton 49 "follow large". This applies to any of the first 24 modules. This is a customer option. refer to section 10. page 10.9 of the manual for details.

On a 'BUS' option module select the BUS source for the small fader by pressing pushbutton 49. Assign the small fader to the mix using pushbutton 50. The small fader now operates as a subgroup fader of any sources assigned to that module number. Use the small pan pot 48 to set the image position.

In all cases auxiliary sends. mutes. etc are operational on the chosen subgroup fader.

GROUPING AND SUBGROUPING WITH SOURCE REVERSE

When you want "LIVE" mic or line inputs on the large faders then operate in SOURCE REVERSE mode. select pushbutton 15.

The BUS/TAPE monitor source selector now connects to the small fader and pan pot. When this is in the BUS mode (56 released) you have BUS OUTPUT on the small fader. This can be re-assigned to another BUS OUTPUT and added to the mix by selecting pushbutton 50.

BUS IN, BUS OUT JACK CONNECTORS

Each M470 module includes access jacks for the BUS OUTPUT and BUS INPUT of the same number. The signal on these is unbalanced at -2dBu signal level and is available for internal patching and any other special requirement. BUS OUTPUT is only useable on the first 24 modules corresponding to BUS OUTPUTS 1-24. BUS INPUTS on modules 25 and higher are connected to the BUS position of the SOURCE selector 56.

UNUSED BUSES

When a console has less than 24 I/O modules then the unused mix buses. eg. 17-24. are terminated with a ground connection to control interbus crosstalk. Should such a console be expanded at a later date then the ground terminations must be removed. Refer to section 10. of the manual.

CUE AND ECHO MIXING

Eight AUXILIARY outputs are available from the M441 stereo master module. These eight outputs are for connection to outboard echo devices. The functions are as follows:

	SMALL PRE	SMALL POST	LARGE PRE	LARGE POST
AUX 1	YES	YES	YES	YES
2	YES	YES	YES	YES
3	YES	YES	YES	YES
4	YES	YES	YES	YES
5	YES	YES	YES	YES
6	YES	YES	YES	YES
7	INTERNAL OPTION	INTERNAL OPTION	YES	YES
8	INTERNAL OPTION	INTERNAL OPTION	YES	YES

Eight five-segment bargraph meters show the outgoing signal levels for Aux 1-8. Note that outputs 1 and 2 can be accessed simultaneously by the small AND large faders, these are the choice when "live" and "track" sources have to be mixed together to create a CUE mix.

Outputs 7 and 8 are accessed by either the small OR the large fader on each M470 module. This is preset with internal solderless links.

Details of the CUE OUTPUTS are given on the M440/M441 module description.

ECHO RETURN inputs 1 and 2 are included on the M440/M441 module, each is a mono input with access to the bus outputs, the stereo mix and aux 1 and 2. These returns are not muted by a SOLO operation.

Additional echo return requirements are provided by M470 module spare faders. Module LINE and TAPE input connections are suitable for echo return purposes.

CUE MIXING

Two stereo outputs CUE 1 and CUE 2 are provided for CUE (foldback) output purposes to studio HEADPHONE circuits. These two outputs include special facilities for selecting the STEREO MIX as a cue source, combining Aux mixes with each other and the stereo mix, and for TALKBACK. Details of the CUE output controls are given on the M440/441 module description.

Decide which source, AUX 1, AUX 2, STEREO MIX is required as the CUE source. The following description assumes aux 1/2 as a stereo CUE mix. On modules which are 'live' inputs select the PRE and SMALL pushbuttons (23,24) to connect the aux 1/2 dual concentric control 22 to the small fader. Open aux 1/2 level controls to approximately position 7, you can introduce individual level variations as required.

Open aux master controls (M440/M441 module) to the 0dB position. Open CUE 1 (or 2) master level control to 0dB or as required for normal listening level in the headphones. Select CUE sources AUX 1 AND AUX 2. You now have aux mix 1 on the left and aux mix 2 on the right of the CUE output.

On modules which are "monitor" sources select pushbutton 33 to connect the aux level and pan controls to the large fader, pre-fader. Now open the aux level control (dual concentric inner) to add the monitor source in aux mixes 1 and 2. The pan control (dual concentric outer) adjusts the stereo position of the monitor source in aux 1/2.

If the STEREO MIX is wanted as the CUE source release the CUE selectors aux 1/2 and select the L-R pushbutton. If you wish to mix a click track for example with the STEREO MIX then send the click track to aux 1, select aux 1 AND L-R as the CUE source. If you want to click track in both sides of the CUE mix select AUX 1, L-R and MONO.

To TALK to CUE pre-select CUE 1 or CUE 2 on the TALKBACK master section and operate the TALK key. TALKBACK level is adjusted on the M450/M451 master module. When CUE talkback is in progress the REVERSE TALKBACK system operates and connects a remote microphone into the control room LS system. For details of this system refer to section 7.11 and 10.

Auxiliary sends are switched between small and large faders. This allows quick reconnection of a send to different faders as a session progresses. For example, you can use controls 22, 23, 24 to send live cue from a small fader during track rehearsal. Then when the track has been recorded you switch 23 from small to large fader the cue mix remains as before but now sourced from the large (pre) fader.

When you send cue from the monitor section (large fader) you avoid even this operation since during rehearsal and the take and afterwards your source is the large (pre) fader source BUS or TAPE signal.

ECHO MIXING

The dual purpose auxiliary outputs 1-8 are all capable of post fader sourcing for echo send purposes. Set the AUX MASTER controls to the 0dB point (M440/1 panel).

During sessions which require CUE mixes sends 1 and 2 are probably already in use. Aux sends 3-8 are available as ECHO SENDS. When CUE mixing does not require the use of Aux outputs then all 8 sends are available for echo mixing.

ECHO SEND FROM M470 INPUT

On input source modules select the chosen aux send controls to be POST the SMALL fader using pushbuttons 23, 24, 26, 27, 29, 30. Turn the controls to obtain the required output level. The dual concentric controls have level for ODD sends on the INNER control - EVEN sends on the OUTER control. The 1-2/7-8 controls are arranged as a LEVEL/PAN set. This set is internally preset on the large fader so is not useful for echo from input purposes unless the preset internal link is changed over. Refer to Section 10.

ECHO SEND FROM M470 MONITOR

On monitor source modules select the chosen aux send controls to be POST the LARGE fader using pushbuttons 23, 24, 26, 27, 29, 30, 32, 33. Turn the controls to obtain the required output level. Note that aux 1-2/7-8 is a level/pan combination. Echo from the monitor source is echo send of the 'track'.

ECHO SEND FROM BUS OUTPUT

When all 8 auxiliary sends are occupied use BUS OUTPUTS via the patchbay to send echo. Assign the fader which needs extra sends to the available BUS OUTPUT. This may require you to operate the pan control and obtain echo send on only one of the two bus outputs assigned. There is a panel control facility which avoids disturbing the pan setting, 'FOLLOW LARGE'.

FOLLOW LARGE

FOLLOW LARGE is a facility which makes use of BUS OUTPUTS as echo sends.

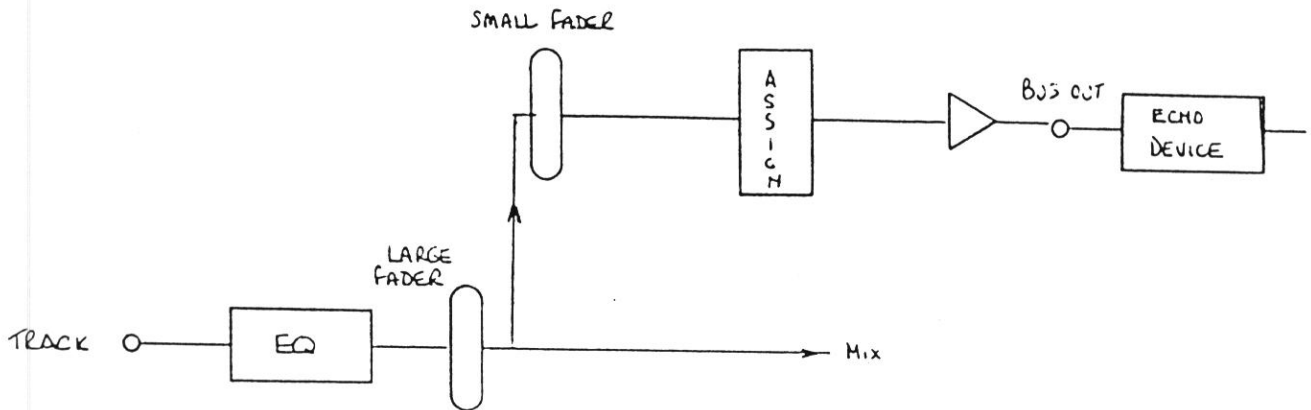

SIGNAL FLOW WITH FOLLOW LARGE SELECTED

Use the FOLLOW LARGE facility to send echo from a large fader when the auxiliary send system is fully occupied.

Note that the BUS OPTION for FOLLOW LARGE pushbutton changes the facility available. Inspect control 49. If the legend BUS appears on the pushbutton the option is fitted and replaces the follow large facility. Refer to GROUPING details and Section 10 page 10.9.

ECHO RETURNS

RETURNS 1 and 2. The master module M440/1 includes two line input return sections RETURN 1 and RETURN 2. These are mono returns for connection to echo device outputs. Each return has access to Aux 1 and 2 for ECHO to CUE mixing, access to bus outputs 1-24 and the stereo mix (L-R).

The Aux control at the top of each RETURN provides level control of the return and the signal is connected to Aux 1 and 2 as selected by the adjacent pushbuttons. This RETURN to AUX facility is internally pre-set to be PRE the return LEVEL control below.

The return LEVEL control adjusts level of echo return to the ASSIGN pushbuttons nearby. BUS outputs 1-24 and the STEREO MIX (L-R) may be selected. ASSIGN operate with the PAN control. Pan LEFT affects ODD outputs, pan RIGHT affects EVEN outputs.

Returns 1 and 2 are not muted by any SOLO operation.

M470 ECHO RETURN OPERATION

Each M470 provides two simultaneous return inputs each with fader and pan.

SMALL FADER: Connect the echo return to the LINE INPUT and select pushbutton 12. Use LINE gain 16 (outer) to adjust the gain before the small fader. Connect the small fader to the mix using pushbutton MIX 50, and PAN 48. Assign the small fader to bus outputs using ASSIGN 17, and SMALL PAN 48. Send echo to AUX using controls 22, 23, 24 selected to PRE, SMALL. Small faders will be muted by SOLO operations for INPUT SOLO but not MONITOR SOLO.

LARGE FADER: Connect the echo return to the TAPE INPUT and select pushbutton 56. Use source trim 57 to adjust the gain before the large fader. The large fader is normally connected to the stereo mix, use PAN 61. Use pushbutton MIX MUTE 58 to cut the return from the mix. Assign the large fader to bus outputs using ASSIGN LARGE 19 and pushbuttons 17 with LARGE PAN 61.

Send echo to AUX using controls 22-33 selected to PRE, LARGE. SOLO SAFE 60 prevents the large fader from muting in response to a MONITOR SOLO operation. Note that you can still initiate a SOLO using the SOLO key 63 on a SOLO SAFE module.

Echo return EQUALISATION can be applied to either the small or large fader as required.

SALES INFORMATION, March 1988

AHB SIGMA SERIES; Patchbay system, 19 inch rack mount.

General Information.

- 1) The location of the Patchbay in the console frame is illustrated.
- 2) The console frame is supported by one stand at each end.
- 3) Right hand Patchbays are standard.
- 4) The Patchbay occupies the producers desk- Patchbay frame space and takes up 8 U of the 15 U available.
- 5) The Patchbay hardware is switchcraft brand "Tini Telephone" metal frame 3 pole jack sockets. 96 sockets are mounted on each 1U panel.
- 6) Internal connections to the console modules are made via the module panel connectors.
- 7) External connections are terminated beneath the Patchbay. The connectors are EDAC 516 series 90 way types and XLR3 types for some master circuits.
- 8) The 90 pin cable connector is available from two manufactures;

VARELCO	8016	090	217	704
EDAC	516	090	500	351
- 9) Individual Patch panel details are illustrated.
- 10) The mating cord is switchcraft type TT 122 (1ft.), TT 126 (3ft.).

STANDARD PATCHBAY SYSTEMS FOR SIGMA M470 IN-LINE CONSOLES.

	CONSOLE FORMAT	CONSOLE FORMAT	CONSOLE FORMAT
	24S + PB 321/0	24L + PB 441/0	24LX + PB 561/0
STANDARD PANELS SUPPLIED	Insert type 3 part filled Multitrack type 4 complete Insert type 5 part filled Masters type 6 complete	Insert type 3 Multitrack type 4 Insert type 5 Masters type 6	Insert type 3 Multitrack type 4 Insert type 5 Masters type 6 Expander type 8
OPTIONAL PANELS	mic in type 1 part filled line in type 2 part filled racks in/out type 7	mic in type 1 line in type 2 racks in/out type 7	mic in type 1 line in type 2 racks in/out type 7
TOTAL	4U 296 JACKS without options	4U 392 JACKS without options	5U 488 JACKS without options

SIGMA 19" PATCHBAY LOCATION



Connector Panel
 Edac 516 90pin x12
 XLR 3M/3F 22 off

PLAN VIEW OF SIGMA & PATCHBAY

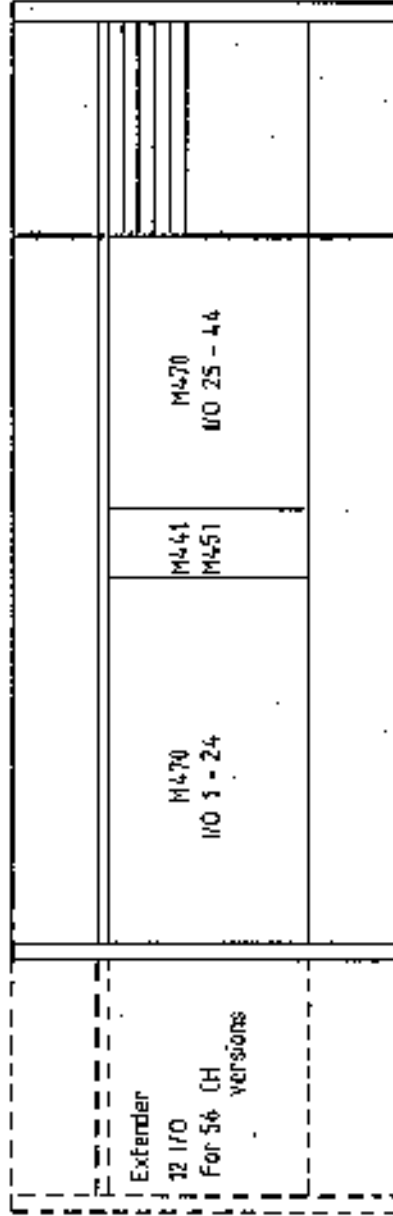

TERMINATIONS:
EDAC 516
90 PIN x 2

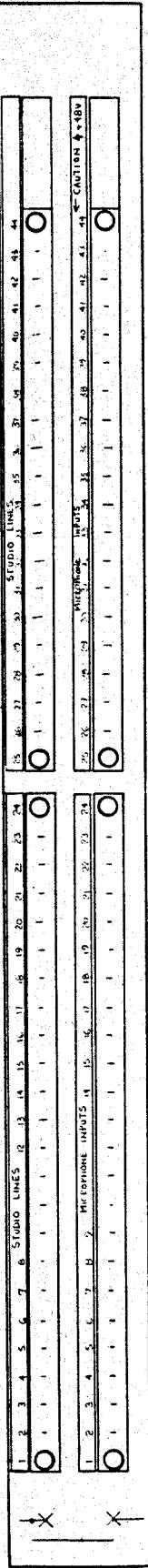

PANEL TYPE 1
(OPTIONAL) B

TERMINATIONS:
EDAC 516
90 PIN x 2

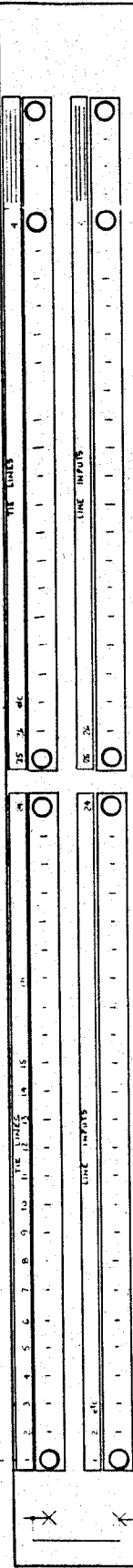

PANEL TYPE 2
(OPTIONAL) B

TERMINATIONS:
EDAC 516
90 PIN x 2

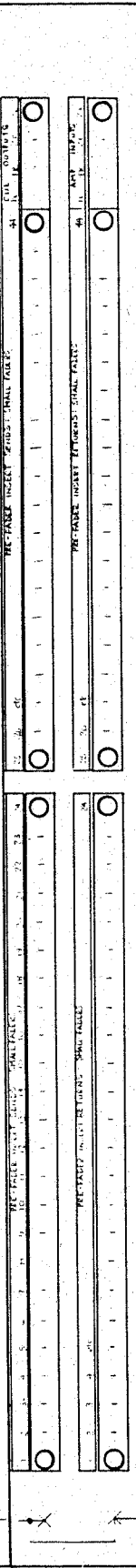

PANEL TYPE 3
(STANDARD) B

TERMINATIONS:
EDAC 516
90 PIN x 2

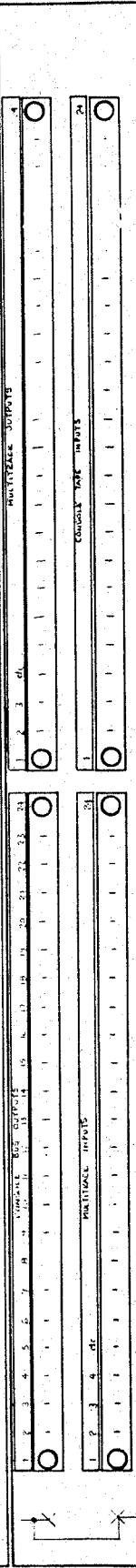

PANEL TYPE 4
(STANDARD) B

TERMINATIONS:
EDAC 516
90 PIN x 1

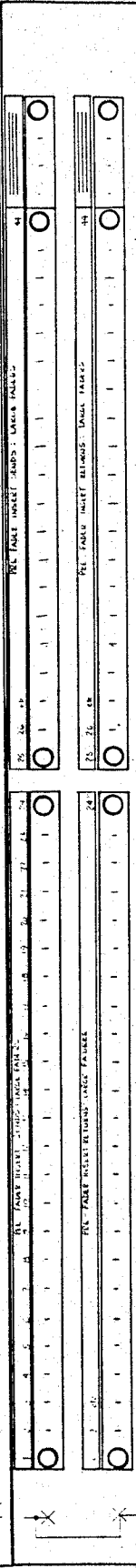

PANEL TYPE 5
(STANDARD) B

TERMINATIONS:
EDAC 516
90 PIN x 1

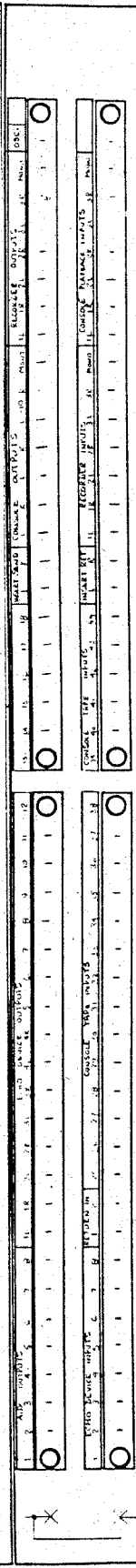

PANEL TYPE 6
(STANDARD) B

TERMINATIONS:
EDAC 516
90 PIN x 4

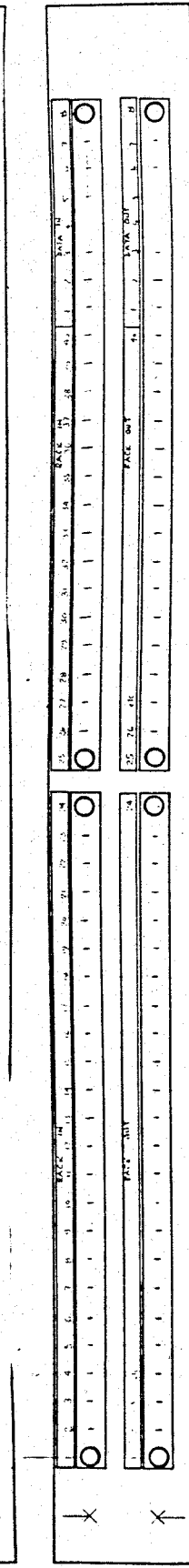

PANEL TYPE 7
(OPTIONAL) B

TERMINATIONS:
EDAC 516
90 PIN x 1

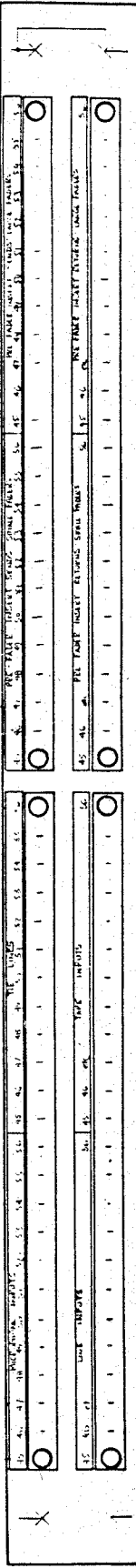

PANEL TYPE 8
(OPTIONAL) B

TERMINATIONS:
EDAC 516
90 PIN x 2

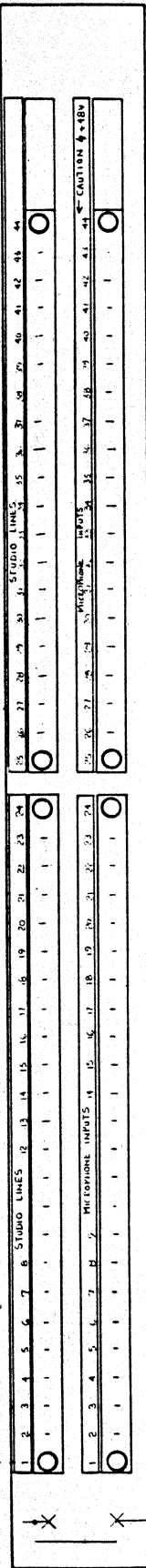

A
PANEL TYPE 1
(OPTIONAL)
B

TERMINATIONS:
EDAC 516
90 PIN x 2

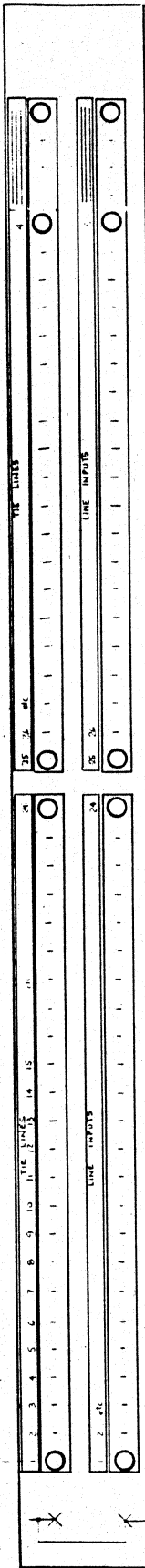

A
PANEL TYPE 2
(OPTIONAL)
B

TERMINATIONS:
EDAC 516
90 PIN x 2

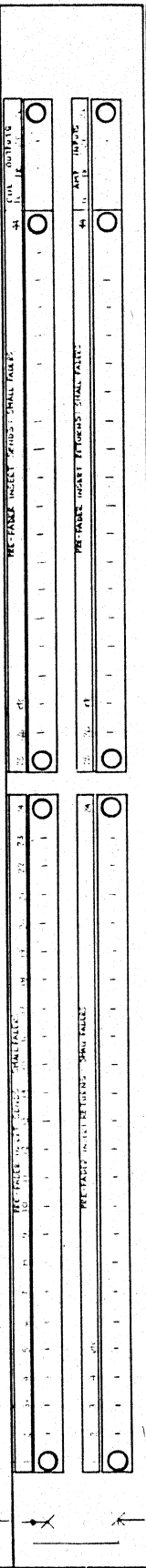

A
PANEL TYPE 3
(STANDARD)
B

TERMINATIONS:
EDAC 516
90 PIN x 2

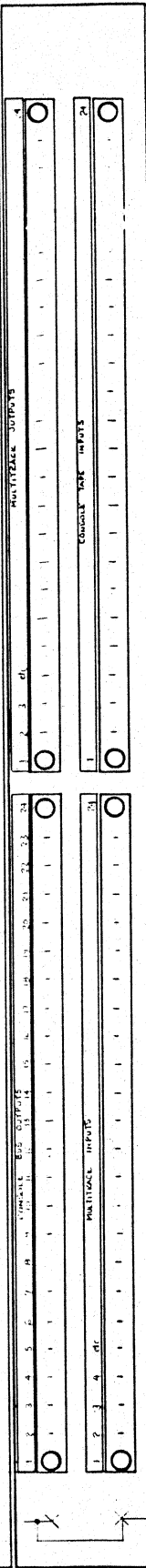

A
PANEL TYPE 4
(STANDARD)
B

TERMINATIONS:
INTERNAL
ONLY

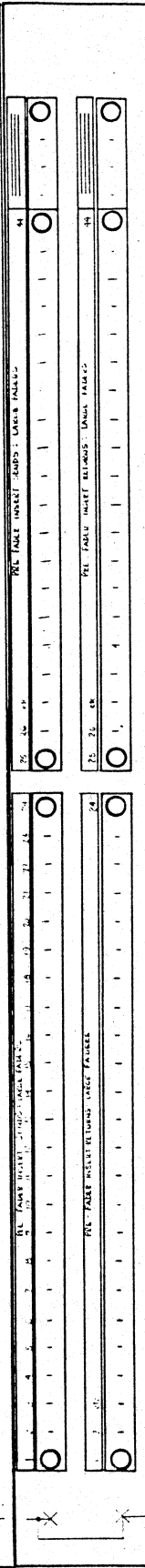

A
PANEL TYPE 5
(STANDARD)
B

TERMINATIONS:
EDAC 516
90 PIN x 1

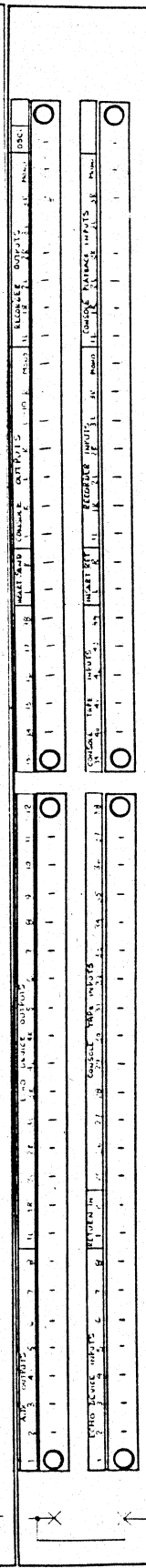

A
PANEL TYPE 6
(STANDARD)
B

TERMINATIONS:
XLR 3M x 15
XLR 5F x 7

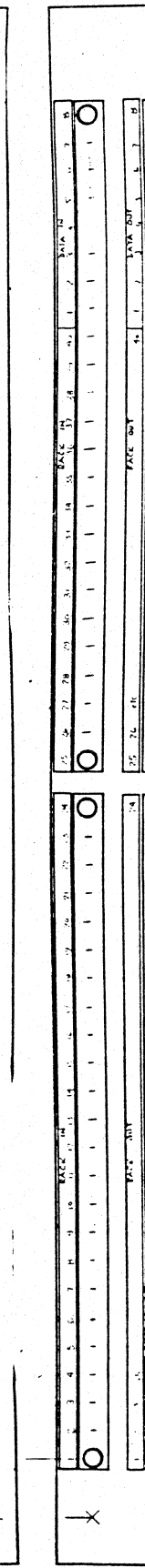

A
PANEL TYPE 7
(OPTIONAL)
B

TERMINATIONS:
EDAC 516
90 PIN x 1

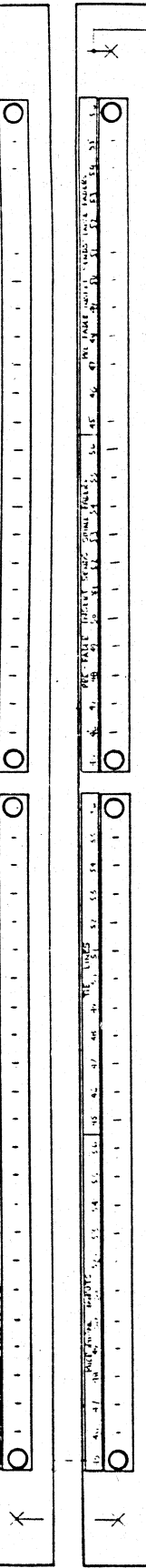

A
PANEL TYPE 8
(STANDARD)
B

FOR 36 CH

PATCHBAY HARDWARE AND CONNECTIONS; 19 INCH SYSTEM.

Consoles are supplied to order having 19" 1U patchbay panels fitted.

Each 19" panel is fitted with metal frame jacks, Switchcraft part number TT34B. These are three pole, with break switches on tip and ring contacts.

Wiring to internal circuits uses the panel connectors on each module.

Wiring to external circuits uses a combination of 90 pin multiway connectors and XLR connectors. Details are shown in the illustrations " 90 pin ch 1-24, 90 pin ch 25-48; patchbay connector panel."

Allocation of audio channels to the connectors is shown below for 44 and 56 channel versions. 32 channel versions use the same connector codes however, only circuits 1-32 are fitted.

TT PANEL TYPE	FUNCTION	CONNECTOR CODE	ALLOCATION
Type 1 mic in	1A Studio lines 1-24	90 Pin A	balanced, 1-24
	1A Studio lines 25-44	90 pin B	balanced, 25-44
Type 2 line in	2A Tie Lines 1-24	90 pin C	balanced, 1-24
	2A Tie Lines 25-44	90 pin D	balanced, 25-44
Type 3 Inserts/ Cue	3B Cue Amp Inputs 1L/R, 2L/R	90 pin G	Unbalanced Pin 2 + 23, 24, AV, AY
Type 4 Multitrack	4B Multitrack in 1-24	90 pin E	balanced 1-24
	4A Multitrack out 1-24	90 pin F	balanced 1-24
Type 5 inserts	Internal only	none	none

Type 6 Masters	6B Echo Inputs 1-8	8 x XLR 3M	Unbalanced pin 2 hot
	6A Echo Outputs 1L-18	90 Pin G	Balanced, 1-22
	6B Recorder Inputs 1L/R, 2L/R, Mono	5 x XLR 3M	Balanced, Pin 2 Hot
	6B Recorder Inputs 3L/R	2 x XLR 3M	Unbalanced Pin 2 Hot -10dBV
	6A Recorder Out- puts, 1L/R, 2L/R, Mono	5 x XLR 3F	Balanced, Pin 2 Hot
	6A Recorder Out- puts, 3L/R	2 x XLR 3F	Unbalanced Pin 2 Hot -10dBV
Type 7 Racks	7A Racks in 1-24	90 Pin H	Balanced, 1-24
	7A Racks In 25-40	90 Pin J	Balanced, 25-40
	7A Data In 1-8	90 Pin J	Balanced, 41-48
	7B Racks Out 1-24	90 Pin K M	Balanced, 1-24
	7B Racks Out 25-40	90 Pin K	Balanced, 25-40
	7B Data Out 1-8	90 Pin K	Balanced, 41-48
Type 8.56 ch.	8A Tie Lines 45-56	90 Pin L	Balanced, 1-12

Unless otherwise specified all signal levels are + 4dBV, nominal.

PATCHBAY NORMALLING.

When there are no plugs in the patchbay most circuits are connected by the jack switch contacts.

For each 1U panel the convention is that the upper row (A) is a "listen" row, that is an output.

The lower row (B) is a "break" row, an input.

Listen jacks on row A are connected via the switch contacts of the B row to the B jack destination.

Putting a plug in a listen jack does not break the switch.

Putting a plug in a break jack breaks the switch and the jack plug programme overrides the switched programme.

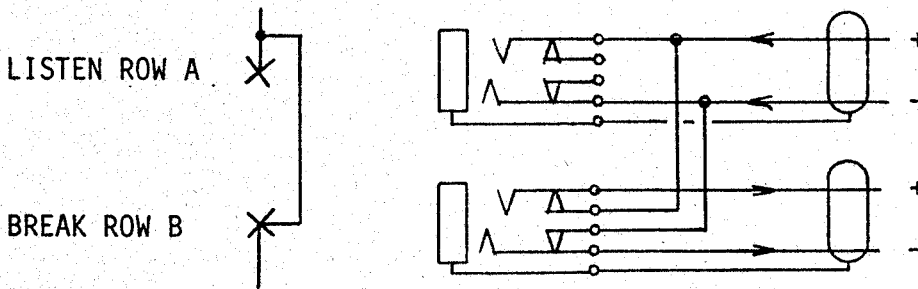

IMPORTANT EXCEPTIONS:

Panel type 7 no normalising

Panel type 8 Mic and line inputs not normalised.

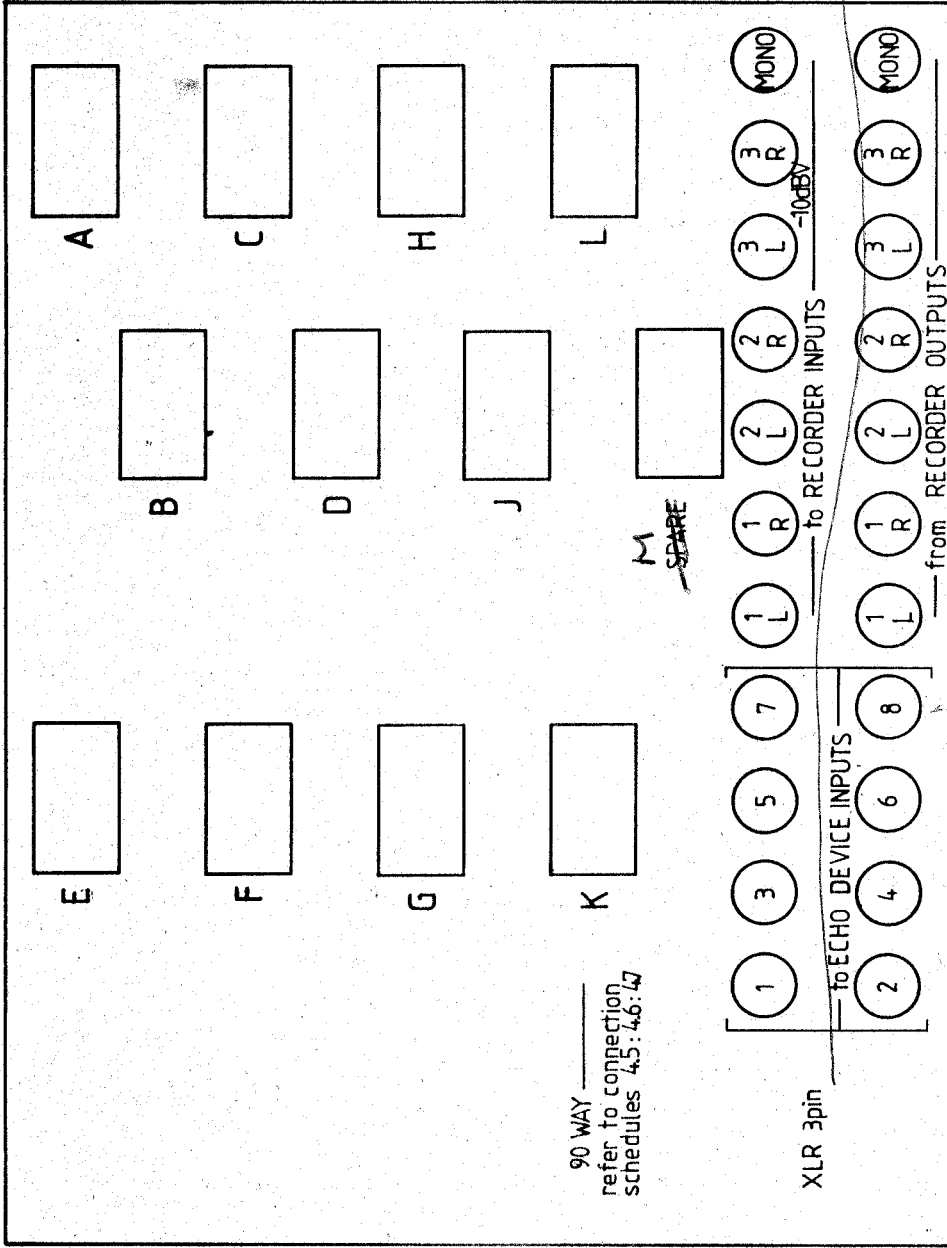

FRONT

AHB SIGMA PATCH-BAY CONNECTOR PANEL (EXTERIOR)

8488/1

DRAWN	REVISION	DATE	CHECKED	UNIT TITLE	
				DRAWING TITLE	
STANDARD NOTES				FINISH	
ALL DIMENSIONS IN mm				GENERAL ± 0.25 mm	
DO NOT SCALE DRAWING				HOLE CENTRES ± 0.15 mm	
THIRD ANGLE PROJECTION				HOLE SIZES ± 0.10 mm	
REMOVE ALL BURRS & SHARP EDGES				UNLESS STATED OTHERWISE	
SCALE				NOTES	
MATERIAL				TOLERANCES	
90 WAY				GENERAL ± 0.25 mm	
90 WAY				HOLE CENTRES ± 0.15 mm	
90 WAY				HOLE SIZES ± 0.10 mm	

90 PIN:CH11-24

AHB SIGMA

NOTE 1, CONN'R L ONLY
TIE LINES 45-56;

45 = 1
46 = 2
56 = 12

NOTE 2,
CONN'R G ONLY
CUE 1L = 23
1R = 24
2L = AV,AZ,BD
2R = AY,BC,BH

INTERNAL
VIEWS

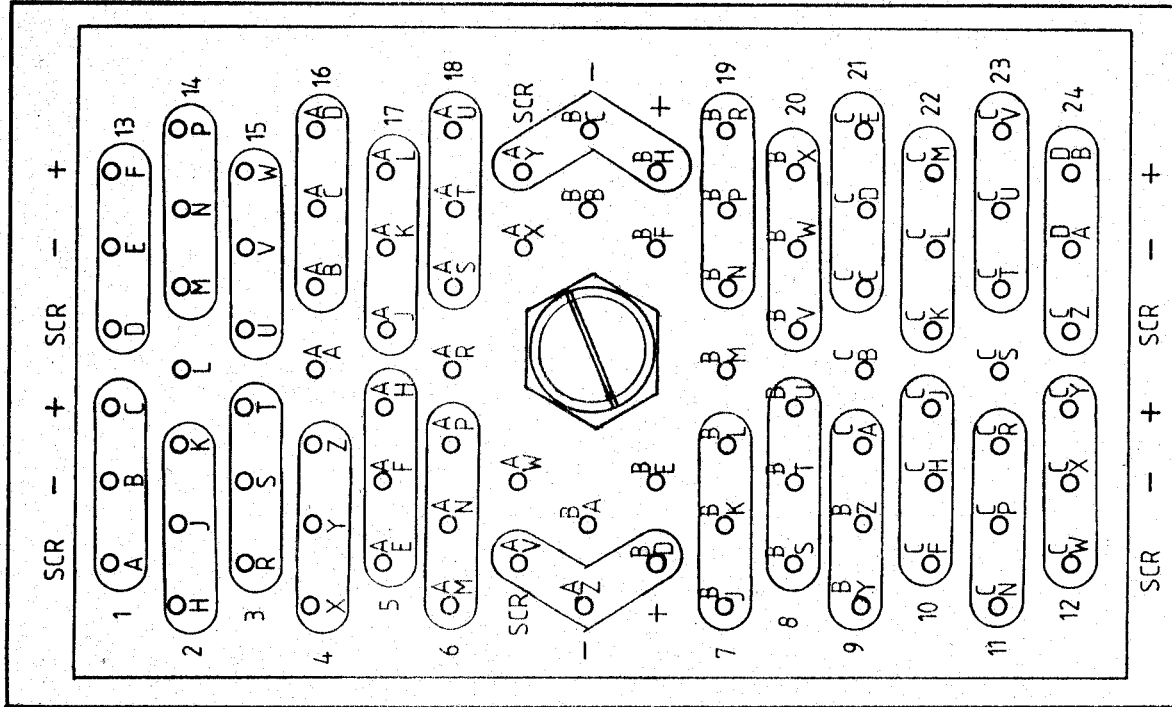

CABLE CONNECTOR (PLUG) EDAC 516 090 000 351 BODY
516 290 590 CRIMP PINS

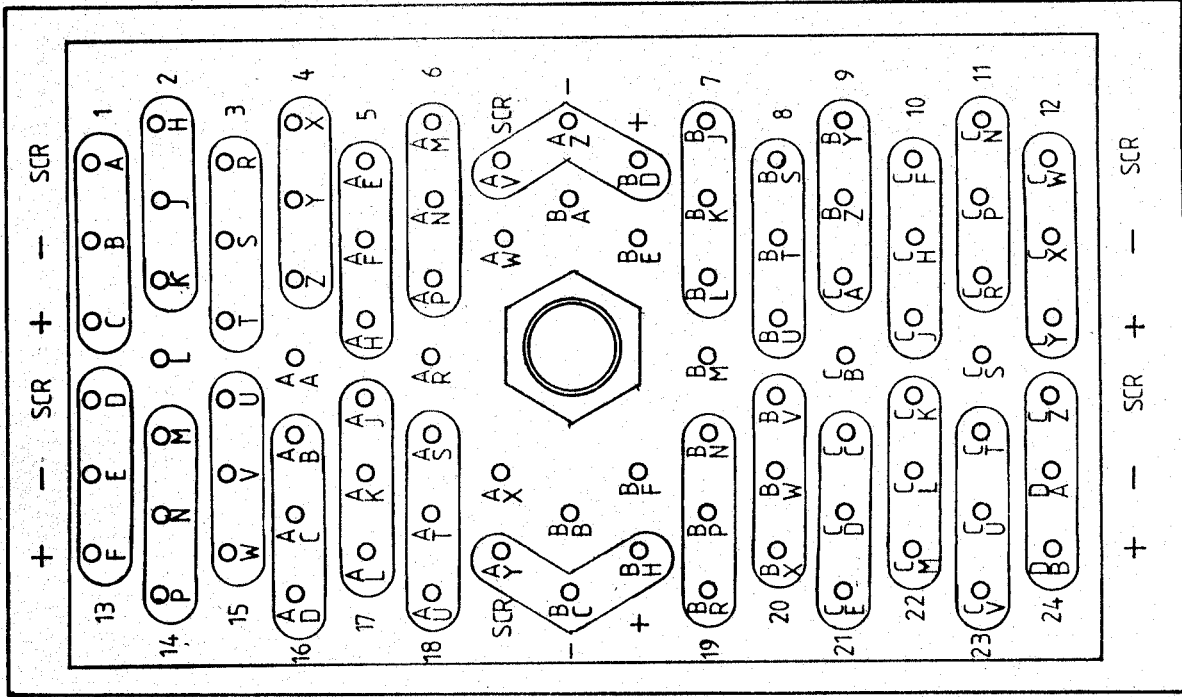

PANEL CONNECTOR (RECEPTACLE) EDAC 516 090 000 402
516 290 590 CRIMP PINS

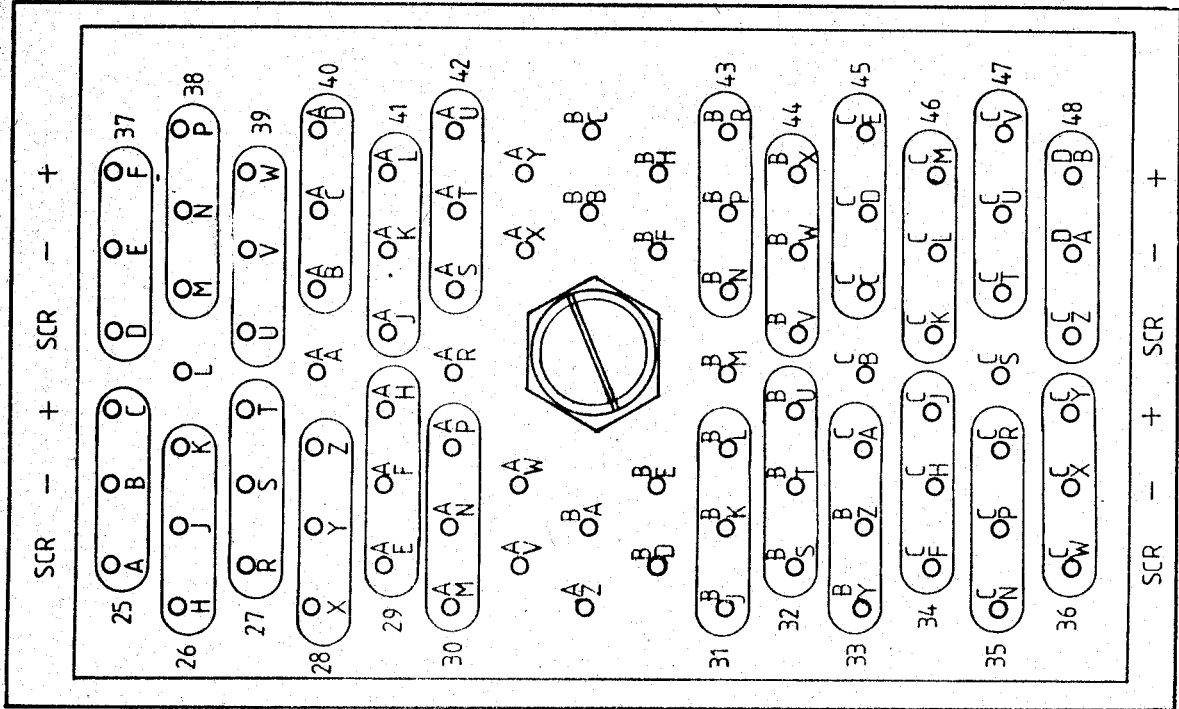

CABLE CONNECTOR EDAC 516 090 000 351 BODY
(PLUG) 516 290 590 CRIMP PINS

INTERNAL VIEWS

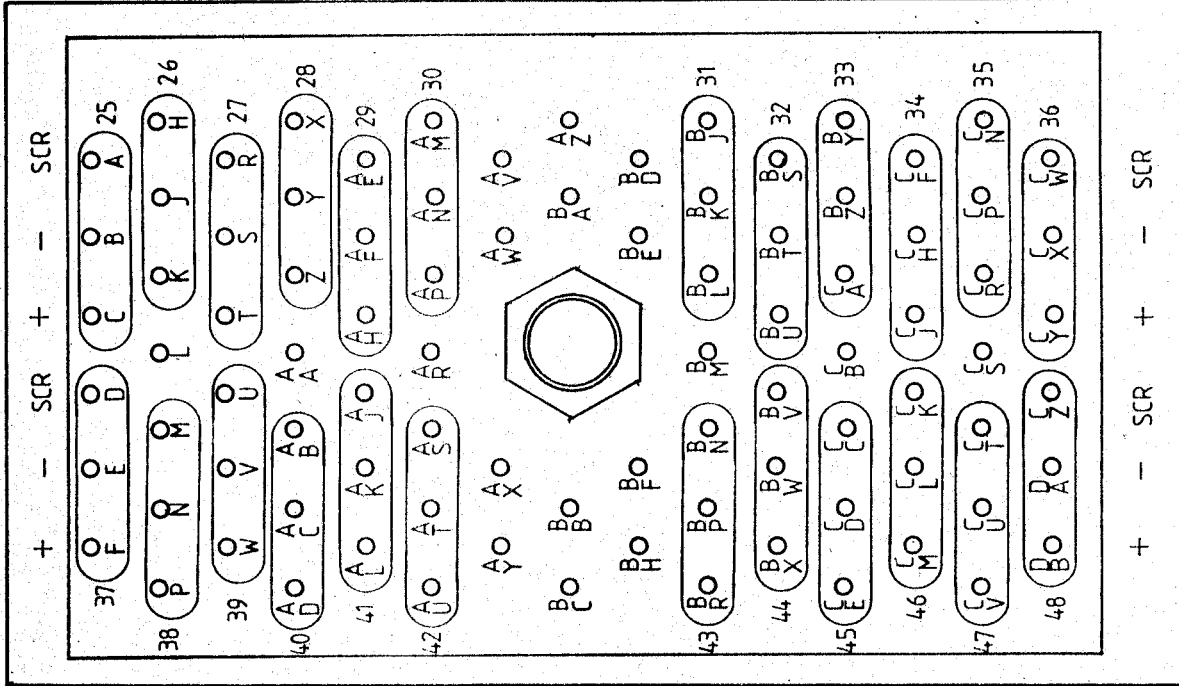

PANEL CONNECTOR EDAC 516 090 000 402
(RECEPTACLE) 516 290 590 CRIMP PINS

AHB VCA DC GROUP SYSTEM

DESCRIPTION

Fader modules M487 are single channel VCA modules complete with 100mm fader and panel.

These replace single analogue fader modules M485.

One VCA master fader module M488 is required by the system.

Each VCA fader connects directly with the corresponding console audio channel via the module fader harness.

One busbar harness interconnects all VCA fader modules and the VCA master module.

High quality VCA components are fitted and trimmed for optimum performance.

No memory of fader position is created.

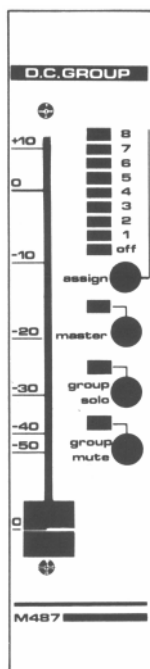

M487 VCA FADER MODULE FEATURES:

- 1) 100mm fader. Full cut-off nearest operator, 10dB gain boost away from operator.
- 2) DC GROUP assign selector and indicator. There is a choice of 8 DC groups plus 'off' where the individual fader is not part of a group.
- 3) MASTER selector and indicator. Any fader can be created master for its own group number. Group master fader movements are followed by all faders assigned to the group. The audio passing through the group master module is faded at the same rate as the slaves are faded.
- 4) GROUP SOLO selector and indicator is active only from the fader modules assigned as masters for groups. When selected it has the effect of muting all other groups of faders. All faders assigned to 'off' will also be muted. If there are faders which should not mute during SOLO, eg. echo returns, these should be selected 'off' and 'group solo'. This combination of 'off', 'not master' and 'group solo' is equivalent to solo inhibit, for the individual fader.
- 5) GROUP MUTE selector and indicator is active only from fader modules assigned as masters for groups. When selected it has the effect of muting all faders assigned to the group. Only groups 1-8 are included in group mute. Faders assigned 'off' are not affected.

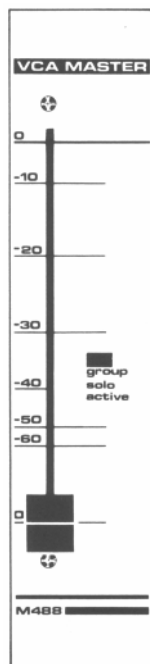

M488 VCA MASTER FADER MODULE FEATURES:

- 1) 100mm fader. Full cut off nearest operator, unity gain away from operator. The action of this fader modifies the settings of all other VCA fader modules connected to the system, ie. a change of 10dB on the VCA master causes a 10dB change on all faders whether assigned as masters or not.
- 2) GROUP SOLO ACTIVE indicator which flashes slowly when group solo is active.

TO ORDER AHB VCA DC GROUP SYSTEM:

- 1) Calculate the number of M410 and M420 modules requiring VCA fader M487 in place of analogue fader M485.
- 2) State on the order the quantity of each module type to be fitted with VCA fader. Where there are more modules than VCA faders ordered the balance of modules will be fitted with analogue M485 faders.
- 3) Where the console includes M430 dual output modules VCA faders are not available for these modules.

- 4) The VCA master fader module M488 is automatically included with the system and is positioned in front of the M450 module next to the analogue L R and Mono master faders.
- 5) The console will be delivered with all hardware fitted and tested.

TO ORDER RETROFIT VCA DC GROUP SYSTEM specify the quantity of VCA fader module M487 required and frame size 24L, 24S and/or extender. All other necessary hardware will be invoiced and delivered.

FADER AUTOMATION: Other Systems

AHB Sigma Series consoles will accept other-brand fader automation which meets the following criteria:

- 1) The active fader modules fit the fader bay, see diagram. Panel width is 38mm, pitch is 38.5mm.
- 2) There is space allowed in the fader bay for additional fader automation control modules that may be needed.
- 3) The gain structure of the modules can provide 10dB attenuation between audio input and output at normal fader position.
- 4) The system includes its own supply of power for the fader modules and does not draw power from the console supplies.
- 5) Audio input and output connections are compatible with the AHB fader interface. This employs 'Molex' type 0.1" pitch female headers on a flying lead from each main audio module. The module send to fader is 0dBv from 22 ohms, the return from fader is — 10dBv into 10K ohms.

Mastermix computer assisted fader mixing, with Digital Grouping, by Audio Kinetics fits the Sigma Console and replaces non — automated AHB M485 faders. Mastermix MX200 type faders are provided finished to match Sigma panels. Fader Interface hardware is located in the console patchbay and occupies 3U of rack space. The Mastermix Automation computer is rack-mounted with the automation power supply either in the console patchbay or in a wall rack. The standard Sigma Mastermix package automates M410 input and M420 group/monitor faders up to a total of 56 faders. The Fader Controller panel is located alongside console Left, Right and Mono output faders which remain non-automated types.

AHB will be pleased to provide quotations for individual systems and can supply some systems ready installed for use on delivery of the console.

When selecting the system account should be made of value for money, inter-studio compatibility and after sales service. The manufacturers guarantee for after sales service is negotiated to be transferred to the end user in the country of use. Where this is not possible AHB will advise the individual circumstances.

SIGMA SERIES FADER BAY ARRANGEMENT RIGHT HAND SIDE OF MAINFRAME TOP ELEVATION WITH 3 FADER PANELS REMOVED

